



APPLICATION TOOLING

FOR AEROSPACE, DEFENSE & MARINE
(AD&M)

Tooling Solutions for Aerospace, Defense and Marine

Introduction to Tooling Solutions

Anyone can make a tool to crimp terminals onto a wire. But not everyone can manufacture a tool to crimp them properly.

Crimp termination of wires isn't easy. At least, doing it right isn't easy. We know. We started it. TE developed the technology of hand crimping over 50 years ago.

Why is this experience important to you? That's easy to answer. It's because along the way we've learned how to crimp correctly. We've learned how the forces of crimping can affect how a tool works, whether it meets specifications, and even whether it reaches its expected service life.

We've led the way, with tool frames and die sets that maintain their geometry and produce consistent crimps time after time after time. There are differences that aren't readily apparent: the materials, the manufacturing processes, the designs to diverse requirements for different applications. These are all part of what we've known and practiced for years.

Your business, your profitability depend on your product yields. When you can take advantage of our quality, selection, and tradition of innovation, why would you choose otherwise?

Crimping correctly saves you money and makes you money.

Make crimp tooling from TE Connectivity your standard.

Finding Equipment Online

tooling.te.com - a dedicated tooling website with:

- Powerful searches to find the right tooling equipment options (hand tools / applicators)
- Brochures and more detailed flyers for the specialized equipment along with local contact information.

It's quick and more importantly the latest and most up to date information is available online.

Enter Terminal Part Number
Navigate to Compatible Parts

Select Desired Filters

Check Availability

TE Connectivity (TE)
Products Industries & Solutions Search Sign In v Resources

RE-INVENT MOBILITY
WATCH ENTREPRENEURS & ENGINEERS ADVANCE TRANSPORTATION >

ENGINEERING INNOVATION FOR CONNECTED TRANSPORTATION

TREND FUTURE OF PERSONAL MOBILITY
The dawn of personalized, on-demand transportation is here, and it marks another step in the goal to connect everything to everyone. From WIREED Brand Lab in collaboration with TE Connectivity.

TREND TAKING A LONGVIEW ON SMART MOBILITY
By integrating core systems and services, municipalities can optimize the mobility of people and goods, a key predictor of success in smart cities.

BETTER, SAFER, LIVE CHAT

Products Compatible with PTL RECEPTACLE CONTACT, 12 AWG (1971)

Filter Results

Tool Grade: Ratchet Configuration: Die Set Type: Specification Type: Tool Type: Samples Available: Apply

Products (5)

PRODUCT
Application Tooling - Hand Tools
HAND NON-LOGIC POWER UNIT
AMP
189721-1
TE INTERNAL NUMBER 189721-1
Tool Grade Premium Crimp Tools
Calibration Certificate No.
Power Type Pneumatic

PRODUCT
Application Tooling - Hand Tools
FOOT NON-LOGIC POWER UNIT
AMP
189722-1
TE INTERNAL NUMBER 189722-1
ALIAS ID: AMPS-0189722-1, D80304-000
Tool Grade Premium Crimp Tools
Calibration Certificate No.
Power Type Pneumatic

TE CONNECTIVITY (TE)
KIT, BTLL, C-HEAD
AMP
2217480-1
TE Internal Number: 2217480-1
Out of Scope for EU RoHS
Out of Scope for EU RoHS
Tool Grade Commercial Crimp Tooling
Die Set Type Removable/Interchangeable
Calibration Certificate: No
Power Type Battery (150v)
Tool Type Base Power Unit (No Crimp Tooling)
> See All Features

North America

DISTRIBUTOR	QUANTITY	DAYS AS OF
NEWARK ELEMENT14 140-040075	3	2017/03/21
DIGKEY ELECTRONICS 140-040075	1	2017/03/22

SAVE TO LIST v FIND SIMILAR PRODUCTS

DOCUMENTATION FEATURES PRODUCT COMPLIANCE

Instruction Sheets
Customer Manual
Standard Die Envelope (SDE) Lithium-Ion Battery Powered Crimping Tool Kits 2217480-1 PDF

About TE Connectivity For Partners Customer Support CALL US LIVE CHAT

Tooling Solutions for Aerospace, Defense and Marine

Contents

Introduction to Tooling Solutions	
TE Application Tooling	
Commercial Aerospace, Defense, Offshore Oil & Gas and Civil Marine (AD&M)	2
1 Crimping Equipment	4
1.1 Tooling available by Product Family	4
■ Insulated Terminals	4
■ Un-Insulated Terminals	6
■ Contacts	6
■ Coaxial Connectors	7
■ Raychem Splices	7
1.2 Premium CERTI-CRIMP and CERTI-CRIMP II Tools	8
■ Hand Tools	9
■ Terminal to Tool Reference	10
■ Power Assist Options for CERTI-CRIMP II Straight Action Hand Tools	13
■ Power Assist Options for Double Action and Heavy Head Hand Tools	14
■ 626 or Micro Pneumatic Terminal to Tool Reference	14
1.3 SDE Commercial Crimp Tooling	15
■ SDE Hand Tools	16
■ SDE Commercial Crimp Tooling - Terminal to Tool Reference	17
■ SDE Commercial Die-Sets for PIDG and PLASTI-GRIP Terminals	18
■ Power Assist Options for SDE Tooling	19
1.4 Power Assist Equipment	20
■ Lithium-Ion Battery Tool 1.5 t	20
■ Lithium-Ion Battery Tool 4 t	21
■ AT-300 Electric Benchtop Crimping Machine with CERTI-CRIMP Adapters	22
■ 626 and Micro Pneumatic Tool System	23
■ 626 Pneumatic Tool System	25
■ 626 and Micro Pneumatic Tool System Configurations and Ordering Information	25
1.5 Hydraulic Equipment	27
■ Hydraulic Tooling Selection Guide - 56,540 kPa / 8,200 psi	28
■ Dies, Hand Tools and Hydraulic Heads Configuration Options - 8,200 psi	29
- SOLISTRAND Terminals	29
- Heavy Duty SOLISTRAND Terminals	30
- SOLISTRAND Flag Terminals	30
- TERMINYL Terminals and Splices	31
- PLASTI-GRIP Terminals and Splices	31
- STRATO-THERM Terminals and Splices	32
- AMPOWER Quick Disconnect Terminals	32
- AMPOWER Terminals and Splices	33
- Sealed Crimp COPALUM Terminals and Splices	34
- Bar Crimp COPALUM Terminals and Splices	34
- Insulation Piercing Crimp COPALUM Terminals and Splices	35
■ Hydraulic Tooling Selection Guide - 70,000 kPa / 10,000 psi	36
■ Dies, Hand Tools and Hydraulic Heads Configuration Options - 10,000 psi	37
- TERMINYL Terminals and Splices	37
- PLASTI-GRIP Terminals and Splices	37
- PLASTI-GRIP Large Expansion Terminals	38
- SOLISTRAND Terminals	38
- Heavy Duty SOLISTRAND Terminals	39
- SOLISTRAND Flag Terminals	39
- AMPOWER Quick Disconnect Terminals	40
- Insulation Piercing Crimp COPALUM Terminals and Splices	40
- AMPOWER Terminals and Splices	41
- Sealed Crimp COPALUM Terminals and Splices	42
- Bar Crimp COPALUM Terminals and Splices	42
- STRATO-THERM Terminals and Splices	43
■ Hydraulic Equipment Options and More Detailed Information for 70,000 kPa / 10,000 psi	44
2 AT Global Services	45
2.1 Field Engineering Organization	45
2.2 Factory-Level Service, Certification and Tool Repair	46
3 Appendix - Useful Information	47
3.1 Wire Range Limits	47
3.2 Computing CMA	48
3.3 Wire Range and Color Codes	49
3.4 Terminal Styles	52
Glossary	53

Tooling Solutions for Aerospace, Defense and Marine

Commercial Aerospace, Defense, Offshore Oil & Gas and Civil Marine (AD&M)

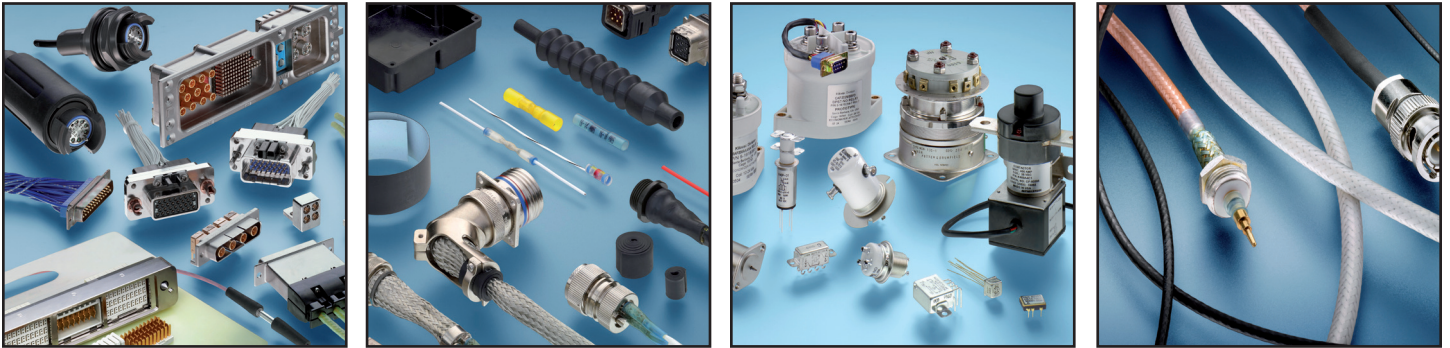

TE Connectivity can help you gain an advantage in the aerospace, defense, and marine (AD&M) industries with our commitment to advanced engineering and world-class manufacturing. For more than 50 years, we've put a premium on delivering innovative products through excellence in design and problem solving.

Connectors and Backshells

Advanced high speed/high bandwidth copper, RF and fiber optic connectors for harsh environments used for inside and outside the box or box-to-box applications. Available Mil-Spec and industry standards (VITA, ARINC, SAE), provide design flexibility for SWaP (size, weight and power) goals.

Wire and Cable

Extensive range of Wire & Cable solutions, including high speed copper and fiber optic hybrids utilizing unique high performance polymer systems and flexible innovative design, to meet challenging demands in AD&M environments.

Relays and Contactors

Design and manufacture of relays, contactors, solenoids, and power distribution units for operation in extremes of temperature, shock, vibration and altitude. Includes COTS (commercial off-the-shelf), Mil-Spec, plus highly specialized, custom-designed products.

Engineered Polymer Solutions

Full range of interconnect products including heat shrinkable components, splices & terminations, backshell and value added assemblies that provide reliable sealing, shielding and mechanical protection. Includes repair products and tooling for harness assembly. For solutions to harness design visit www.HarnWare.com.

Tooling Solutions for Aerospace, Defense and Marine

Commercial Aerospace, Defense, Offshore Oil & Gas and Civil Marine (AD&M)

Commercial Aerospace – www.te.com/CommAero

In passenger transports, turboprops and business jets, our connectors, fiber optics and relays keep today's aircraft wired for success.

Military Aerospace – www.te.com/MilAero

The demands of the fixed, rotary wing and UAV markets depend on products that are reliable, maintainable, cost effective and technologically advanced and that is why we are an integral part of this growing industry.

Electronic Systems/C4ISR – www.te.com/C4ISR

We offer a full range of solutions to optimize system performance, ranging from emerging technology commercial-off-the-shelf (COTS) to full military QPL products.

Space – www.te.com/Space

Space applications mean extreme conditions and demand the best in lightweight composition, innovative design and reliability.

Missile Defense – www.te.com/missile-defense

The backbone to securing and protecting any nation requires a missile defense system that protects against any incoming threat. Our products are specifically tailored to provide cost effective solutions that help provide success.

Ground Defense – www.te.com/Ground-Defense

Ground defense not only presents challenging environments, it also requires heightened system compatibility. Our components offer superior electrical interconnection performance under these extremely rugged conditions.

Military Marine

TE has a proven track record of providing rugged solutions to meet the harsh demands of the military marine environment.

Offshore and Commercial Marine – www.te.com/Offshore

Offshore and subsea environments pose some of the most extreme weather, pressure, weight, and corrosion challenges to electronic systems and equipment. Our materials science expertise, sealing technology, and systems approach to electronic interconnect help our customers navigate through the harsh conditions found in marine applications.

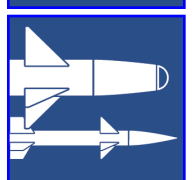
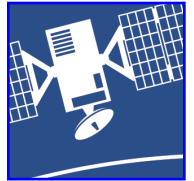

Tooling Solutions for Aerospace, Defense and Marine

1 Crimping Equipment

1.1 Tooling Available by Product Family

Insulated Terminals

Connector/ Terminal	Style	Wire Range (AWG)	Hand Tools	
			Premium CERTI-CRIMP and CERTI-CRIMP II	SDE Premium Dies
			Section 1.2	Section 1.3
				
PIDG	Terminals and splices	26 to 24	X	
		22 to 18	X	X
		16	X	X
		14	X	X
		12 to 10	X	X
	Terminals and splices (radiation resistant)	24 to 14	X	
		12 to 10	X	
	Terminals and Splices (insulation restricting nylon)	26 to 14	X	
		12 to 10	X	
		Spare wire caps	22 to 14	X
		12 to 10	X	
PLASTI-GRIP	Splices	26 to 24	X	
		22 to 14	X	
		12 to 10	X	
		8	X	
	Terminals	26 to 24	X	
		22 to 14	X	X
		12 to 10	X	X
		8	X	
	Terminals and splices	6		
		4 to 4/0		
PIDG STRATO-THERM with special or peek insulation	Terminals	24 to 16	X	
		14	X	
		12 to 10	X	
TERMINYL	Terminals and splices	8		
		6		
		4 to 4/0		

Tooling Solutions for Aerospace, Defense and Marine

Power Tools				
Battery Tool 1.5 t	Battery Tool 4 t	Hydraulic Equipment	626 Pneumatic Tool	Crimping Machine
Section 1.4	Section 1.4	Section 1.5	Section 1.4	Sections 1.3, 1.4



X			X	
X			X	X
X			X	
X			X	X
	X		X	X
X				
	X			
X				
	X			
X				
X			X	
	X			
X			X	
X			X	X
	X		X	X
	X		X	
	X			
	X			
X			X	X
X			X	X
	X		X	X
	X	X	X	
	X	X		
		X		

Tooling Solutions for Aerospace, Defense and Marine

Un-Insulated Terminals

Connector/ Terminal	Style	Wire Range (AWG)	Hand Tools		Power Tools				
			Premium CERTI-CRIMP and CERTI-CRIMP II	SDE Premium Dies	Battery Tool 1.5 t	Battery Tool 4 t	Hydraulic Equipment	626 Pneumatic Tool	Crimping Machine
			Section 1.2	Section 1.3	Section 1.4	Section 1.4	Section 1.5	Section 1.4	Sections 1.3, 1.4
SOLISTRAND	Terminals and splices	26 to 24	X		X				
		22 to 18	X		X			X	X
		16 to 14	X		X	X		X	X
		12 to 10	X		X				X
		8 to 6				X	X	X	
		4 to 2					X		
		0 to 600 MCM					X		
COPALUM		16 to 10						X	
		8					X	X	
		6 to 500 MCM					X		
STRATO-THERM	Terminals (with and without insulation support)	22 to 14	X		X			X	
		12 to 10	X			X		X	
		8 to 2/0					X		
TERMI-FOIL		8						X	
AMPOWER		1/0 to 1500 MCM					X		

Contacts

Connector/ Terminal	Style	Wire Range (AWG)	Hand Tools		Power Tools				
			Premium CERTI-CRIMP and CERTI-CRIMP II	SDE Premium Dies	Battery Tool 1.5 t	Battery Tool 4 t	Hydraulic Equip- ment	626 Pneumatic Tool	Crimping Machine
			Section 1.2	Section 1.3	Section 1.4	Section 1.4	Section 1.5	Section 1.4	Sections 1.3, 1.4
Screw-machined contacts									
AMPLIMITE D-sub	Size 22 DF	28 to 22	X					X	
	Size 20 DF	28 to 20	X					X	X
AMPMODU	AMPMODU IV	26 to 20	X					X	X
	Locking clip	26 to 22	X					X	X
	Mini tandem spring	32 to 28	X					X	X
	MTE pin	32 to 22	X					X	X
	Short point	32 to 20	X					X	X
MATE-N-LOK	Commercial	30 to 14	X					X	X
	Universal	24 to 14	X					X	X
	Universal II	24 to 14	X					X	X
	Mini Universal	20 to 16	X					X	X
	Mini Universal II	26 to 16	X					X	X
MR Connector	Contacts	26 to 18	X					X	X
CPC	Type II		X					X	X
	Type III+	30 to 14	X					X	X

Tooling Solutions for Aerospace, Defense and Marine

Coaxial Connectors

Connector/ Terminal	Style	Wire Range (AWG)	Hand Tools		Power Tools				
			Premium CERTI-CRIMP and CERTI-CRIMP II	SDE Premium Dies	Battery Tool 1.5 t	Battery Tool 4 t	Hydraulic Equipment	626 Pneumatic Tool	Crimping Machine
			Section 1.2	Section 1.3	Section 1.4	Section 1.4	Section 1.5	Section 1.4	Sections 1.3, 1.4
50 Ohm BNC		26 to 24		X	X			X	X
50 Ohm SMB		22 to 18		X	X			X	X

Raychem Splices

Connector/ Terminal	Style	Wire Range (AWG)	Hand Tools		Power Tools				
			Premium CERTI-CRIMP and CERTI-CRIMP II	SDE Premium Dies	Battery Tool 1.5 t	Battery Tool 4 t	Hydraulic Equipment	626 Pneumatic Tool	Crimping Machine
			Section 1.2	Section 1.3	Section 1.4	Section 1.4	Section 1.5	Section 1.4	Sections 1.3, 1.4
MiniSeal		26 to 12	X	X	X			X	X
DuraSeal		26 to 12	X	X	X			X	X

Tooling Solutions for Aerospace, Defense and Marine

1.2 Premium CERTI-CRIMP and CERTI-CRIMP II Hand Tools

- Designed to exacting specifications
- Ratchet control provides complete crimping cycle
- For most military, UL and CSA applications
- Manufactured using high quality materials
- Requires minimum skill
- Repairable
- Calibrated; recalibration recommended every 6 months or 5,000 cycles
- Produced under a quality management system certified to ISO 9001

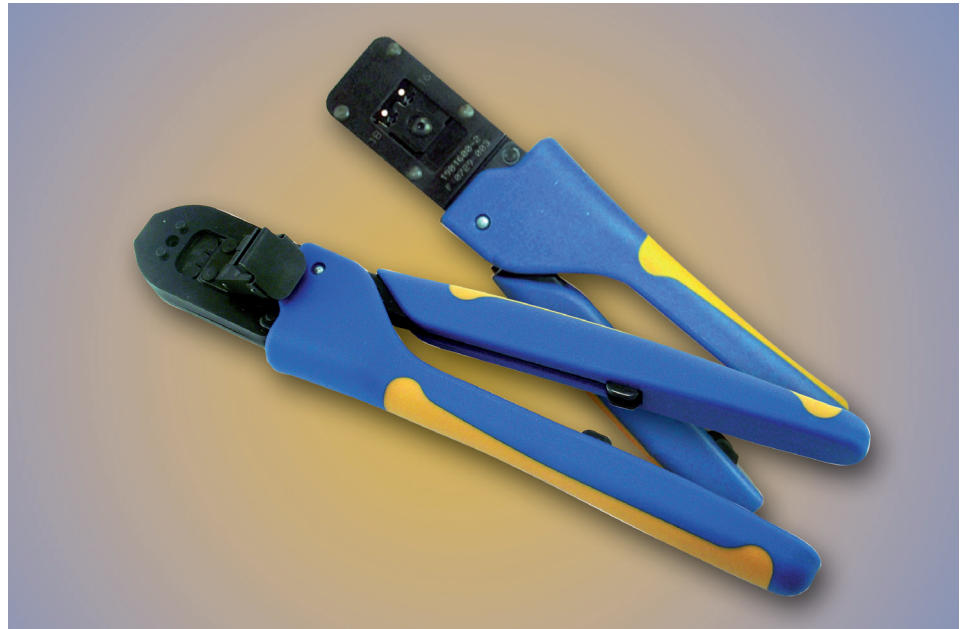

CERTI-CRIMP hand tools are top-of-the-line, premium, hand-operated tools for crimping a broad array of terminals, contacts and special wiring devices available from TE Connectivity. They are designed to exacting specifications to produce consistent, high-quality terminations. A potential service life of over 50,000 cycles is possible, depending on operator care.

Other features include insulation crimp adjustment for different insulation thicknesses, a locator for properly positioning and supporting the terminal or contact in the tool, a wire stop, and color coding and/or wire size information on the head of the tool or on the handles.

All CERTI-CRIMP hand tools feature the reliable ratchet control. The ratchet will not release until the handles are fully closed and the dies bottomed. This helps eliminate partial crimps.

CERTI-CRIMP hand tools are well suited for low production runs, prototype work, and repairs almost any application requiring consistent, highly-reliable terminations.

CERTI-CRIMP hand tools are designed to meet all feature requirements listed on applicable TE Connectivity application specifications.

(Check appropriate product catalogs for qualification to military specifications, UL recognition and CSA certification.)

Tooling Solutions for Aerospace, Defense and Marine

Hand Tools



CERTI-CRIMP II Straight Action Hand Tool (SAHT)

- Dies close in a straight line
- Contact locator and support
- Wire stop
- Insulation crimp adjustment (4 positions)
- Ejects crimped contact
- Approx. weight 0.59 kg [1.3 lb]



Double Action Hand Tool (DAHT)

- Dies travel in arc-like path
- Locator on tools for FASTON, MATE-N-LOK, PIDG and PLASTI-GRIP terminals
- Insulation adjustment on tools for FASTON, MATE-N-LOK, PIDG and PLASTI-GRIP terminals
- Approx. weight 0.54 kg [1.2 lb]



Heavy Head Hand Tool (HHHT)

- Designed to terminate most large coaxial cable and heavy-gage wire
- Dies close in a straight line
- Locator and wire stop when applicable
- Insulation adjustment on tools for PIDG and PLASTI-GRIP terminals
- Approx. weight 0.95 kg [2.1 lb]



T-Head Hand Tool

- Dies close in a straight line
- Locator
- Quick take-up on handle for holding terminal or splice in place
- Adjust insulation crimp with a four-position screw
- Approx. weight 0.59 kg [1.3 lb]

Heads are Compatible With:				
	Battery Kits	Micro Pneumatic	Pneumatic 6-26	Crimping Machine
Double Action HT	Yes	Yes	Yes	No
Heavy Head HT	Yes	No	Yes	No
CERTI-CRIMP II Straight Action HT	Yes	Yes	Yes	Yes
CERTI-CRIMP II Straight Action HT large die	Yes	No	Yes	Yes
T-head HT	Yes	Yes	Yes	No
C-head HT	Yes	No	Yes	Yes

Battery Tool 1.5 T

- Light weight and fully mobile power assist option
- Compatible with all standard die sets



626 and Micro Pneumatic Tool for CERTI-CRIMP II, Straight Action (SAHT) and Double Action (DAHT)

- Effortless crimping for a broad range of terminals
- Either bench-mounted or handheld for working in cramped quarters



C-Head Straight Action Hand Tool,

- Dies close in a straight line
- Dies are interchangeable
- Locators and other applicable features included with dies
- Approx. weight 0.86 kg [1.9 lb]



Tooling Solutions for Aerospace, Defense and Marine

Premium CERTI-CRIMP and CERTI-CRIMP II Terminal to Tool Reference

Insulated Terminals		Sleeve	Wire Range		Insulation Range	Hand Tool Type and PN	
Terminal Type	Style	Colour / Stripe	mm≈	AWG	Diameter [mm]	DAHT	
						HHHT	
PIDG	Terminals and splices	Yellow	0.1-0.4	26-22	2.08 max	46121	
		White	0.16-0.65	24-20	2.54 max	47907-1	
		Red	0.26-0.96	22-18	3.18 max	47386	
		Green	0.5-1.42	20-16 HD	3.81 max	47387	
		Blue	1.04-2.62	16-14	4.32 max		
		Yellow / Black	1.04-2.62	16-14 HD	6.35 max	59239-4	
		Yellow	2.62-6.64	12-10			
	Terminals and splices (radiation resistant)	Translucent / White	0.16-0.65	24-20	2.54 max	47907-1	
		Translucent / Red	0.26-0.96	22-18	3.18 max	47386	
		Translucent / Blue	1.04-2.62	16-14	4.32 max	47387	
		Translucent / Black	1.04-2.62	16-14 HD	6.35 max	59239-4	
		Translucent / Yellow	3.0-5.0	12-10			
	Terminals and splices (insulation restricting nylon)	Yellow / Black	0.15	26	0.66-1.4	46121	
		Yellow / Blue	0.24	24	0.79-1.4		
		Red / Green	0.38	22	0.97-1.4	47386	
		Red / Red	0.6	20	1.17-2.79		
		Red / White	0.96	18	1.42-2.79		
		Blue / Blue	1.42	16	1.6-3.3	47387	
		Blue / Green	2.15	14	1.98-3.3		
		Yellow / Yellow	3.37	12	2.41-5.08	59239-4	
		Yellow / Brown	6.11	10	3.02-5.08		
		Spare wire caps (nylon)	Red	0.3-0.85	22-18	3.15 max	47386
	Blue		1.4-2.0	16-14	3.78 max	47387	
	Yellow		3.0-6.0	12-10	5.33 max	59239-4	
	PLASTI-GRIP	Terminals & butt splice	Yellow	0.1-0.41	26-22	2.03 max	46121
		Butt splice	Red	0.26-1.65	22-16	4.32 max	45160
		Parallel splice					45449
		Butt splice	Blue	1.04-2.62	16-14	5.46 max	45575-1
		Parallel splice					45450
		Butt splice	Yellow	2.62-6.64	12-10	7.62 max	59489
Parallel splice		16-14 HD			59270		

■ DAHT ■ HHHT

Tooling Solutions for Aerospace, Defense and Marine

Premium CERTI-CRIMP and CERTI-CRIMP II Terminal to Tool Reference

Insulated Terminals		Sleeve	Wire Range		Insulation Range	Hand Tool Type and PN
Terminal Type	Style	Colour / Stripe	mm≈	AWG	Diameter [mm]	
						DAHT
						HHHT
						CERTI-CRIMP II
PLASTI-GRIP	Terminals	Red	0.26-1.65	22-16	5.08 max	47386
		Blue	1.04-2.62	16-14	6.35 max	47387
		Yellow	2.62-6.64	12-10	7.62 max	59239-4
		Red	6.64-10.5	8	9.14 max	69959
	Butt splice	Red			6.35 max	
PIDG STRATO-THERM with PTFE or peek insulation	Terminals (thin-wall insulation)	Brown	0.25-0.4	24-22	0.89-1.9	576778
		Grey	0.6	20	1.14-2.03	576779
		Brown	0.25-0.4	24-22	0.89-1.9	1901611-1
		Grey	0.6	20	1.14-2.03	
		Orange	1.0	18	1.4-2.67	576780
			1.2	16		576781
			1.0-1.2	18-16		1901600-1
		Beige	2.0	14	2.3-3.18	576782
			3.0	12		576783
		Black	5.0	10	2.6-5.44	576784

Uninsulated Terminals - No Insulation Support		Wire Range		Hand Tool Type and PN
Terminal Type	Terminal Style	mm ²	AWG	
SOLISTRAND	Terminals and splices (except flat tongue terminals)	0.1-0.41	26-22	DAHT
		0.2-0.6	24-20	HHHT
		0.26-1.65	22-16	69363
		1.04-2.62	16-14	
		2.62-6.64	12-10	
		1.65-4.17	14-12	49592
		6.64-10.50	8	69355
		49935		

For battery tool kit with adapter for CERTI-CRIMP II options see section 1.4

■ DAHT ■ HHHT ■ CERTI-CRIMP II

Tooling Solutions for Aerospace, Defense and Marine

Premium CERTI-CRIMP and CERTI-CRIMP II

Terminal to Tool Reference

Terminals		Wire Range		Insulation Range	Hand Tool Type and PN
Terminal Type	Terminal Style	mm≈	AWG	Diameter [mm]	CERTI-CRIMP II
AMPLIMITE D-sub	Size 20 DF	0.08-0.24	28-24	0.76-1.00	91503-1
		0.2-0.6	24-20	1.27-1.52	
	Size 22 DF	0.09-0.15	28-26	0.76-1.27	91520-1
		0.2-0.39	24-22		
AMPMODU	MODU IV	0.12-0.24	26-24	1.02-1.52	91517-1
		1.32-0.38	22		
		0.12-0.51	26-20	1.22 max	91516-1
		0.2-0.6	24-20	1.75 max	
	Locking clip	0.12-0.38	26-22	0.97-1.57	91533-1
	Mini tandem spring receptacle MTE pin	0.03-0.09	32-28	1.52-0.64	1901786-1
	Short point receptacle MTE pin	0.12-0.38	26-22	0.91-1.42	91531-1
	Short point receptacle	0.03-0.09	32-28	0.64-1.52	91518-1
		0.12-0.38	26-22		
		0.2-0.6	24-20	0.64-1.52	91551-1
MATE-N-LOK	Commercial	0.05-0.38	30-22	0.89-1.4	91515-1
		0.05-0.6	30-20	1.02-1.91	
		0.2-0.6	24-20	1.52-2.54	91512-1
		0.81-0.96	18		
		0.5-2.1	20-14	2.54-3.3	91504-1
	Universal Universal II	0.2-0.38	24-22	2.54 max	91510-1
		0.51-0.96	20-18		
		0.51-0.96	20-18	3.30 max	91500-1
		1.2-2-1	16-14		
		0.51-0.96	20-18	5.08 max	91508-1
		1.2-2.1	16-14		91506-1
	Mini-Universal	0.5-0.96	20-18	2.0-3.0	91536-1
		1.42	16	2.49-3.2	
	Mini-Universal II	0.12-0.24	26-24	1.19-1.60	91529-1
		0.32-0.38	22	1.5-1.75	
		0.32-0.6	22-20	1.5-2.01	91522-1
		0.81-0.96	18	2.11-2.39	
		0.5-0.89	20-18	2.0-3.2	91594-1
		1.42	16	2.49-3.2	
	MR connector	MR contacts	0.12-0.38	26-22	1.27-2.79
0.5-0.96			20-18		
CPC M series	Type II	Terminal PN Specific			91539-1
	Type III+	0.05-0.38	30-22	0.89-1.4	91515-1
		0.05-0.6	30-20	1.02-1.91	
		0.2-1.6	24-20	2.03-2.54	91523-1
		1.81-1.42	18-16		
		0.2-0.6	24-20	1.14-1.78	91505-1
		1.81-1.42	18-16	2.03-2.54	
		0.81-1.42	18-16	2.03-2.54	91519-1
		1.94-2.14	14		

Tooling Solutions for Aerospace, Defense and Marine

Power Assist Options for CERTI-CRIMP II Straight Action Hand Tools

The CERTI-CRIMP II tool adapter can be used with the following tools

- Battery tools
- 626 or micro pneumatic
- Electric crimping machine

Battery tool heads can be removed from hand tools, or the head only is available as a [-3] option.

Example PN 91503-1; handles can be removed or alternatively PN 91503-3 (head only) can be purchased and used in the shown power-assist options.



Battery Tool Kit with Adapter for CERTI-CRIMP II Hand Tool	
110 V power plug with CERTI-CRIMP II tool adapter	PN 2217482-1
220 V EU power plug with CERTI-CRIMP II tool adapter	PN 2217482-2

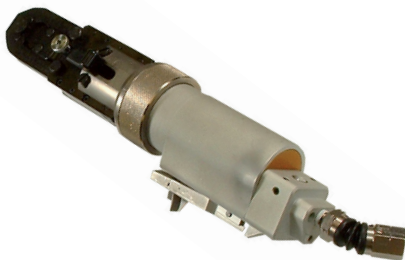

626 or Micro Pneumatic Tool with CERTI-CRIMP II Tool Adapter	
CERTI-CRIMP II tool adapter for 626 or micro pneumatic tool	PN 1583527-1



Crimping Machine with CERTI-CRIMP II Tool Adapter	
CERTI-CRIMP II tool adapter for electric crimping machine	PN 1213860-1

For more information on the 626 and micro pneumatic system see section 1.4

For more information on the crimping machine see section 1.4

Tooling Solutions for Aerospace, Defense and Marine

Power Assist Options for Double Action and Heavy Head Hand Tools

626 Pneumatic Tool

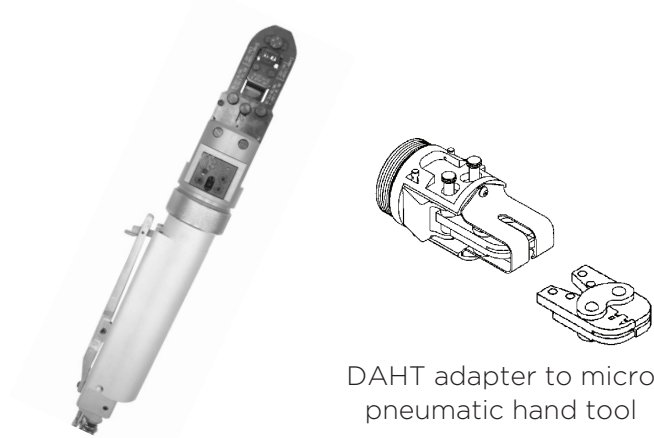

DAHT adapter to micro pneumatic hand tool

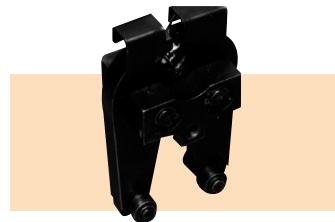

Crimping head for large tool holder



Crimping head for small tool holder

Crimping Heads for 626 Pneumatic Tool	
Large tool holder	PN 356304-1
Small tool holder	PN 356303-1

Adapters to 626 Pneumatic Tool	
DAHT adapter	PN 1213563-1

626 or Micro Pneumatic Terminal to Tool Reference

Terminal Type	Wire Range		Crimping Heads		
	mm≈	AWG	626	626	Micro
PIDG terminals and splices PLASTI-GRIP terminals	1.3-2.0 HD	16-14 HD	679300-1		
	3.0-6.0	12-10			
	0.12-0.3	26-22		314537-1	
	0.3-1.3	22-16			314270-3
	1.3-2.0	16-14			314269-1
PLASTI-GRIP butt splices	0.3-1.3	22-16			314868-1
	1.3-2.0	16-14			314869-1
Closed end splice insulated	0.9-8.0	ECV 18-8			
	0.9-6.0	CES 18-10			
	0.3-2.0	22-14		354422-1	
	0.3-1.3	VS 22-16		217205-1	
	0.3-6.0	EC 22-10		354422-2	
STRATO-THERM terminals and splices	0.3-6.0	22-10	217206-1		
SOLISTRAND uninsulated terminals and splices	0.3-6.0	22-10	679301-1		
	8.0	8	1338757-1		
	13.0	6	1338758-1		
	0.3-3.0	22-14			189989-1
	0.3-1.3	22-16			314516-1
	1.3-2.0	16-14			314517-1
	2.0-3.0	14-12			314518-1

Tooling Solutions for Aerospace, Defense and Marine

1.3 Standard Die Envelope (SDE) Commercial Crimp Tooling



SDE (standard die envelope) is a flexible approach to crimp tooling, that allows use of the same dies on tooling across a range of application platforms. Dies are interchangeable in tools from portable hand tools - manual or battery-powered - to pneumatic hand tools and electric bench terminators.

It is a family of tools that you can take from bench to production or into the field, without the need for dies fitted to each kind of tool.

SDE dies will fit your long-term needs because they are compatible with SDE system power assist tools. They move with you as your needs grow.

Fast Facts

These versatile hand tools are ideally suited for R&D, networking applications, and on-site maintenance work.

- User-adjustable ratchet control for a complete crimping cycle
- Emergency ratchet release
- Angled head, providing a comfortable hand and wrist position
- Over 200 interchangeable SDE die sets to crimp a broad range of connectors
- Able to handle multiple wire and terminal sizes in one die set
- Precision construction of durable high-carbon steel
- Extra strength pivot pins for maximum durability
- Engineered and manufactured using processes independently certified to internationally recognized quality standards ISO-9001:2000 and telecommunications industry standard TL 9000.

Tooling Solutions for Aerospace, Defense and Marine

SDE Hand Tools



PRO-CRIMPER III Hand Tool

Part No. 354940-1

The PRO-CRIMPER III hand tool combines the versatility of general purpose service tools with the reliability and ease of use of many premium grade tools. It is ideally suited for R&D prototyping, networking applications, and commercial, industrial, and institutional maintenance work.

The precision design and manufacturing techniques that go into this tool ensure reliable, repeatable performance. The handles and head design result in increased usable lifecycle.

Versatile. As part of the SDE family of tools, the system accommodates dozens of interchangeable dies in an ever-expanding range, including those for open-barrel contacts and terminals. Many die sets have multiple cavities for crimping more than one wire or terminal size at the same time.

Dependable. The tool is constructed of durable high-carbon steel with extra strength pivot pins, for maximum reliability and long-life precision. Locators are included with pin-and-socket style tools. They help properly locate the contact in the die set, provide a wire stop, and help minimize contact rotation and bending during crimping.

Convenient. User convenience and comfort features are evident throughout. User-adjustable ratchet control is provided for complete crimp cycling that helps eliminate partial crimps. An emergency ratchet release allows the user to open the tool jaws at any time during the crimp cycle. To reduce handle force, the linkage was designed to match the forces required to crimp our largest insulated terminal. The result is dramatically less hand force than comparable tools. The angled head and specially designed handles provide comfortable operation.

Quality. Every tool crimps with precision, because every tool incorporates the traditional quality of all TE Connectivity products.

Tooling Solutions for Aerospace, Defense and Marine

SDE Commercial Crimp Tooling - Terminal to Tool Reference

Product Family	Catalog Number	TE Connectivity Product	RG/U Cable Wire Size	Termination Type/Style	Part Number	
					PN 354940-1 with SDE Die Set	SDE Die Set Only
Coaxial connector	82074	50 Ohm BNC and TNC	RD 316, 180, 195, Belden 8218	"O"/Commercial	—	58539-1
			58, 62, 59	"O"/Commercial	58433-1	58435-1
				Hex/Commercial	58433-2	58436-1
			Belden 9248, 9114	"O"/Commercial	—	58539-1
			174, 188, 316, 179, 161, 187	"O"/Commercial	318450-1	318450-2
		62, 59	"O"/Commercial	—	58435-1	
		50 Ohm BNC	Belden 9907, 89907, Comm/Scope 2104	"O"/Commercial	318452-1	318452-2
			174, 188, 316, 179, 161, 187	Hex/Commercial	—	58436-3
			62, 59, Belden 9104, 9112	"O"/Commercial & military	—	58537-1
			Belden 8281, 9141	Hex/Commercial	—	58436-2
				"O"/Commercial & military	—	58538-1
			180, 195, Belden 8218, 9248, 9114	"O"/Commercial	—	58539-1
		58	"O"/Military	—	220189-3	
		75 Ohm BNC and TNC	62, 59	"O"/Commercial	—	58536-1
			6, Belden 8281	"O"/Commercial	—	58538-1
		75 Ohm BNC	179, 161, 187	"O"/Commercial	318451-1	318451-2
				Hex/Commercial	58531-2	58425-2
			62, 59	Hex/Commercial	58531-1	58425-1
			Double braid 59, Belden 8281, 9141	Hex/Commercial	58531-3	58425-3
			Belden 9248, 9114	"O"/Commercial	—	58536-1
			Belden 8218	"O"/Commercial	—	58174-1
		50 and 75 Ohm BNC	6, Belden 8281	"O"/Commercial	—	58538-1
		50 Ohm N	58, 62, 59	Hex/Commercial	58433-2	58436-1
			8, 213, 11, 216, 9, 214	Hex/Commercial	58501-1	58485-1
		Miniature UHF	58	Dual crimp	58506-3	220196-1
		50 Ohm SMB	174, 316, 188, 179, 161, 187, RD 316, 188 Double Braid	Hex/Commercial	58500-1	58489-1
				Hex/Military	58499-1	58483-1
			178, 196, 174, 316, 188, 179, 161, 187	Hex/Commercial	—	58046-1
		50 and 75 Ohm consumer BNC	58, 62, 59	"F" / "O"	58558-1	58558-2
			174, 316, 188, 179, 161, 187	"F" / "O"	58559-1	58559-2
		Series F CATV plugs	58, 6, 7, 6.6, 8.2, 9.8 [0.259, 0.324, 0.384] dia.	Hex/Commercial	58621-1	58621-2
			58, 6.7, 7.4, 8.7 [0.290, 0.343] dia.	Hex/Commercial	58622-1	58622-2
			59,6 9.1 [0.360] Dia.	Hex/Commercial	58663-1	58663-2
Braid-Pic braid termination	58, 62, 59	—	—	220195-1		

Tooling Solutions for Aerospace, Defense and Marine

SDE Commercial Crimp Tooling – Terminal to Tool Reference

Product Family	Catalog Number	TE Connectivity Product	Cable or Wire Size	PN 354940-1 with SDE Die Set	SDE Die Set Only
Fiber optic connectors	82164 and 296355	FSMA and ST-Style (S.S.) connectors (504XXX Series only)	3.0 mm jacket dia.	58551-1*	58552-1
		ST-Style FC type, D4 and AMP SC connectors	3.0 mm jacket dia.	58433-4*	58424-1
		ST-Style (ceramic) connectors	3.8 mm jacket dia.	— *	503890-1
		FC Type and AMP SC connectors (next generation)	3.0 mm jacket dia.	503911-1**	503910-1
		FSD, FSD MC and RSD connectors; FSD breakout kit	DUALAN and LDD	58519-1*	58510-1
		LightCrimp XTC connectors (ceramic/polymer/S.S.)	3.0 mm jacket dia.	503568-1*	503567-1
		LightCrimp SC (ceramic) connectors	3.0 mm jacket dia.	503699-1*	503698-1
	1307099	LightCrimp Plus AMP SC	3.0 mm jacket dia.	492623-1***	492622-1
		LightCrimp Plus ST-Style	3.0 mm jacket dia.	492782-1***	492783-1
	—	Multimate contacts	1.0 mm plastic fiber, 2.2 mm jacket dia.	217211-1	217211-2

Request catalog for detailed product information.

* Tool frame Part No. 58532-1

** Tool frame Part No. 58588-1

*** Tool frame Part No. 58532-2

SDE Commercial Die-Sets for PIDG and PLASTI-GRIP Terminals

Part Number	Description	AWG / mm ² /Other
91963-2	PIDG, PLASTI-GRIP terminals and splices – equivalent crimp to 47387 Qualifications: Mil-T-7928; LUL RSE 024 pt6 and EE6161 Marks the applied product with a two dot indent code.	16-14 / 1.5-2.5 20-16 / 0.6-1.5 HD
91964-2	PIDG, PLASTI-GRIP terminals and splices – equivalent crimp to 47386 Qualifications: Mil-T-7928; LUL RSE 024 pt6 & EE6161 Marks the applied product with a two dot indent code.	22-16 / 0.4-1.5
91965-2	PIDG, PLASTI-GRIP terminals and splices – equivalent crimp to 59239-4 Qualifications: Mil-T-7928; LUL RSE 024 pt6 and EE6161 Marks the applied product with a two dot indent code.	12-10 / 4.0-6.0

Only the most popular options are listed here, please use our online search by terminal PN to find the right tool for your application, and contact us where information is unclear or missing – there may well be something available for your requirement.

Tooling Solutions for Aerospace, Defense and Marine

Power Assist Options for SDE Tooling



SDE 626 Pneumatic Tool

- PN 1213855-1, complete all pneumatic unit
- PN 679304-1, SDE head only

For more information on the 626 system see section 1.4



Battery Tool Kit

- SDE “Open Head” kit for shoulder-type SDE dies, 110 V plug, PN 2217480-1
- SDE “Open Head” kit for shoulder-type SDE dies, 220 V EU plug, PN 2217480-2
- SDE closed head kit for pin-type SDE dies, 110 V plug, PN 2217481-1
- SDE closed head kit for pin-type SDE dies, 220 V EU plug, PN 2217481-2

For more information on the battery tool kits see Section 1.4



AT-300 Electric Crimping Machine

- PN 1490076-2
Portable bench-top unit with SDE head and foot switch
- PN 1673663-2
Adapter only for SDE dies

For more information on the crimping machine see Section 1.4

Tooling Solutions for Aerospace, Defense and Marine

1.4 Power Assist Equipment Lithium-Ion Battery Tool 1.5 t

The kits are supplied in a durable carry case and include:

- Battery tool
- Battery charger
- Two batteries

Spares:

- Battery PN 2217332-1
- Battery charger 220 V EU power plug PN 2217331-2
- Battery charger 110 V power plug PN 2217331-1

Crimping Tool (with Battery Installed)	
Length	337 mm [13.25 in]
Width	73 mm [2.87 in]
Depth	114 mm [4.5 in]
Mass weight (w/battery)	1.8 kg [4.0 lbs]
Sound level	75 dB(A) at 1 m
Vibration	<2.5 m/s ²
Hydraulic oil	Shell Tellus® T 15

Crimping Capacities	
Maximum crimping force	15.6 kN [3,500 lbs]
Average crimping time	2 seconds
Average crimps per charge	Approximately 150



Rotating Nest Battery Tool (dies not included)	
110 V power plug	PN 2844090-1
220 V EU power plug	PN 2844090-2



T-Head Battery Tool (dies not included)	
110 V power plug	PN 2217485-1
220 V EU power plug	PN 2217485-2



CERTI-CRIMP II SA Battery Tool (heads not included)	
110 V power plug	PN 2217482-1
220 V EU power plug	PN 2217482-2



CERTI-CRIMP DA Battery Tool (heads not included)	
110 V power plug	PN 2217483-1
220 V EU power plug	PN 2217483-2



CERTI-CRIMP HH Battery Tool (heads not included)	
110 V power plug	PN 2217484-1
220 V EU power plug	PN 2217484-2

HH = Heavy Head DA = Double Action SA = Straight Action

Tooling Solutions for Aerospace, Defense and Marine

Lithium-Ion Battery Tool 4 t Latch Head

The kits are supplied in a durable carry case and include:

- Battery tool
- 4 t latched head
- Battery charger
- Two batteries

Spares:

- Battery PN 2217332-1
- Battery charger 220 V EU power plug PN 2217331-2
- Battery charger 110 V power plug PN 2217331-1



Crimping Tool (with Battery Installed)	
Length	337 mm [13.25 in]
Width	73 mm [2.87 in]
Depth	114 mm [4.5 in]
Mass weight (w/battery)	1.8 kg [4.0 lbs]
Sound level	75 dB(A) at 1 m
Vibration	<2.5 m/s ²
Hydraulic oil	Shell Tellus [®] T 15

Crimping Capacities	
Maximum crimping force	35 kN [8,000 lbs]
Average crimping time	2 seconds
Average crimps per charge	Approximately 150

4 t Latched Head Battery Tool Kit	
110 V power plug	PN 2217330-1
220 V EU power plug	PN 2217330-2

Insulated Terminals	Style	Wire Range		Insulation Range	Die Set
		mm ²	AWG	Ø mm max.	
PIDG, STRATO-THERM (PTFE & peek insulation)	Terminals (thin-wall insulation)	3.0	12	2.3-3.18	PN 1976976-1
		5.0	10	2.6-5.44	PN 1976977-1
PLASTI-GRIP TERMINYL	Terminals and splices	7-8.5	8	Non ins. crimp	PN 1901006-1
	Terminals and splices	13-15	6		PN 1901007-1

Uninsulated Terminals No insulation support	Style	Wire Range		Nest	Identer
		mm ²	AWG		
SOLISTRAND	Terminals and splices	7-8.5	8	PN 1901001-1	PN 1901002-2
		13-15	6	PN 1901000-1	PN 1901002-1
		21	4	PN 1901000-2	PN 1901002-1

Tooling Solutions for Aerospace, Defense and Marine

AT-300 Electric Benchtop Crimping Machine with CERTI-CRIMP Tool Adapters



This all electric portable bench-top crimping machine is fast, effortless and ideal for low to medium volume production.

- PN 167377-2 crimping machine
- PN 679304-1 SDE head adapter
- PN 1213860-1 CERTI-CRIMP II straight action head adapter
- PN 1901556-1 C-head SAHT adapter
- PN 1673664-1 optional foot switch

Main powered unit – nor air required
Switchable 110 V or 220 V supply
Cycle counter
Two stage crimp cycle option

Dimensions [mm] 390 x 260 x 200
Weight 13 kg [28.7 lbs]

PIDG and STRATO-THERM Die Sets for Crimping Machine with C-Head SAHT Adapter

Color	AWG	Die Set
Brown	24-22	PN 576711
Grey	20	PN 576720
Orange	18	PN 576715
Orange	16	PN 576714
White / Beige	14	PN 576716
White / Beige	12	PN 576742
Black	10	PN 576723

Tooling Solutions for Aerospace, Defense and Marine

626 and Micro Pneumatic Tool System

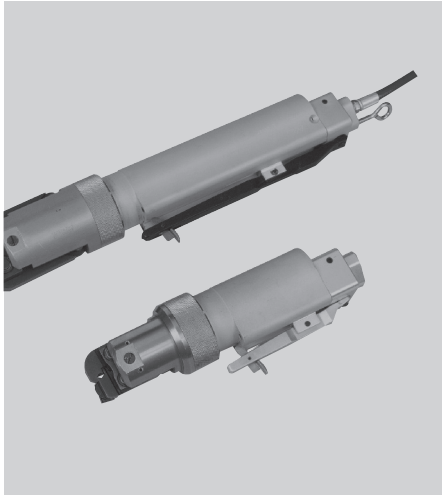

Maximize your productivity while minimizing your effort – replace your manual hand tools with the 626 pneumatic tool system. Terminating wires from 0.12–13.0 mm² [26–6 AWG] has never been easier. And you can continue to use most, if not all, of your existing TE Connectivity compatible crimp heads and die sets.

The 626 System Works Where and How You Need It

Using 626 adapters, tools previously restricted to prototype or limited production applications can now be used in low to medium bench production and harness assembly operations. Because the 626 crimp head can be rotated to any angle, you can

Fast Facts

Effortless crimping for a broad range of terminals, either bench-mounted or hand-held for working in cramped quarters.

- Lightweight tool eliminates physical force required by hand tools
- Hand- or foot-switch operation
- Termination wire range from 0.12–13.0 mm² [26–6 AWG], plus coaxial and fiber optic cable
- Works with existing TE Connectivity compatible crimp heads and die sets
- Ratchet control option provides complete crimp cycle, eliminating partial crimps
- Use rotating head assembly to reach difficult termination locations
- Engineered and manufactured using processes independently certified to internationally recognized quality standards ISO-9001:2000 and Telecommunications Industry Standard TL 9000

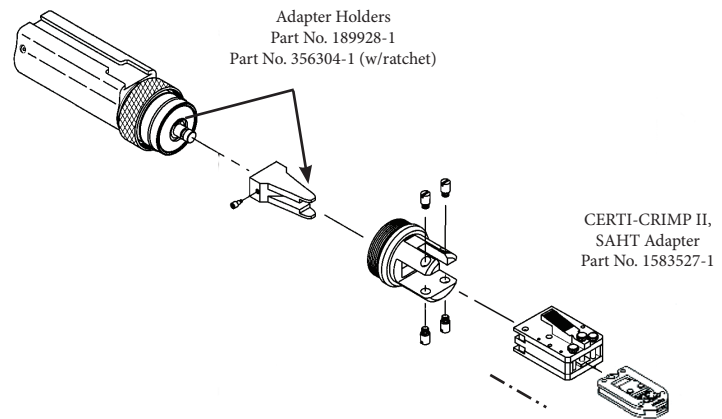

The powerful 626 pneumatic tool system makes crimping as easy as pressing a hand or foot switch. Besides reducing operator fatigue, this means you do not have to design your production bench around your tool. Include the fully adjustable bench mount assembly with the foot switch, and you are completely free to concentrate on aligning the wire and terminal. Now you can crimp faster and with fewer mistakes.

also work on those difficult terminations in confined equipment cabinets or enclosures. Looking for the complete crimp cycle control provided by the mechanical ratchet in premium CERTI-CRIMP hand tools? The available 626 system ratchet tool holders produce a complete crimp cycle by simply pressing a switch. Dies will fully bottom before you can open the jaws to release the crimped product.

Tooling Solutions for Aerospace, Defense and Marine

626 and Micro Pneumatic Tool System

626 Pneumatic System Power Unit



Outside Diameter	45 mm [1.8 in]
Length	225 mm [8.88] for foot actuated unit 230 mm [9.00 in] for hand actuated unit
Grip span	55 mm [2.19 in] over button/handle
Mass	0.60 kg [1.32 lbm] for foot actuated unit
Air pressure	600-700 kPa [90-100 psi]
Air displacement	0.00018 m ³ [11.14 in ³]
Air supply hose	3.05 m [10 ft] long 4.8 mm [3/16 in] I.D. with 1/8 in NPT fitting
Cycle time	0.7-0.8 s (for 16-14 AWG [1.3-2 mm ²] PIDG terminals)

Protect Your Tool Investment

The 626 system's power unit works with a variety of adapters and tool holders, so you can continue to work with your existing crimp heads and die sets.

Big Return in a Micro Package

Does your crimping application demand even more accessibility and flexibility than the 626 system offers?

The micro pneumatic tool system terminates wires in the 0.12-2 mm² [26-14 AWG] range,* but with a smaller and lighter power unit. Weighing in at only 0.7 kg [1.5 lb] and just 146.5 mm [5.75 in] long, the hand-actuated micro system is compatible with three different head systems.

* With the exception of the SOLISTRAND tool head combination, which crimps 0.3-2 mm² [22-10 AWG] combinations.

Die Interchangeability

For the ability to change dies quickly when needs change, whether from one terminal type to another or from tool to tool when workload and environment change, consider the SDE family of tools and dies.

For more information, see Catalog 1773379-1.

Micro Pneumatic System Power Unit



Outside diameter	45 mm [1.8 in]
Length	146.5 mm [5.75 in]
Grip span	55 mm [2.19 in] over button/handle
Mass	0.70 kg [1.5 lbm]
Air pressure	600 - 700 kPa [90-100 psi]
Air displacement	0.00018 m ³ [11.14 in ³]
Air supply hose	3.05 m [10 ft] long 4.8 [3/16 in] I.D. with 1/8 in NPT fitting
Cycle time	0.7-0.8 s (for 16-14 AWG [1.3-2 mm ²] PIDG terminals)

Tooling Solutions for Aerospace, Defense and Marine

626 Pneumatic Tool System

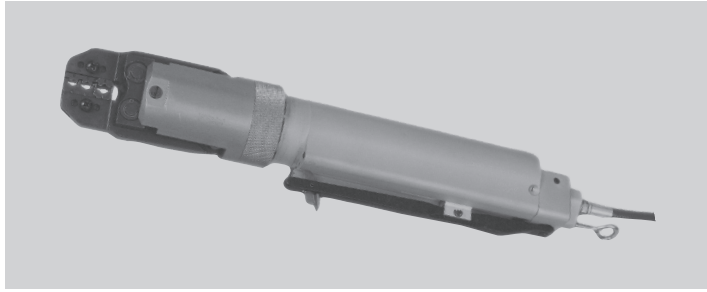

SDE Compatible Kit

Complete tool with hand-held power unit	PN 1213855-1	0.3 - 6.0 mm ² (22-10 AWG)
---	--------------	--

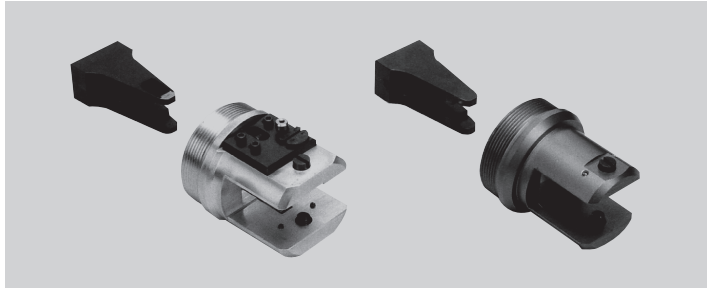

Tool and Adapter Holders*

	Large Tool Holder	Small Tool Holder	Adapter Holder
Length (with head assembly)	100 mm [3.88]	70 mm [2.75]	70 mm [2.75]
Weight (with head assembly)	0.76 kg [1.68 lb]	0.44 kg [0.96 lb]	0.44 kg [0.96 lb]
PN	356302-1	356303-1	356304-1

*Measurements are averages.

626 and Micro Pneumatic Tool System Configurations and Ordering Information

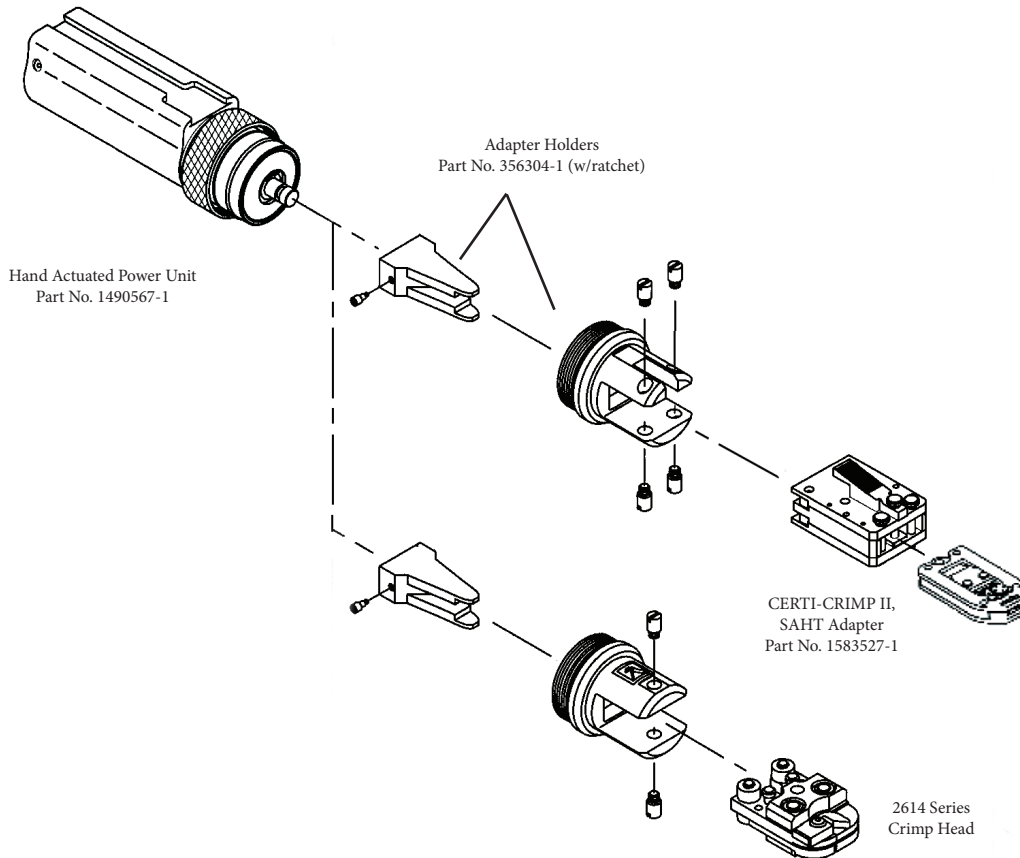

Tooling Solutions for Aerospace, Defense and Marine

626 and Micro Pneumatic Tool System Configurations and Ordering Information

The basic 626 and micro pneumatic tool systems require a power unit, a tool holder, a head assembly, and a die set, when applicable. Tool holder assemblies (i.e., tool holder and cam) accept the crimping heads, adapters, and die sets listed in section 1.2

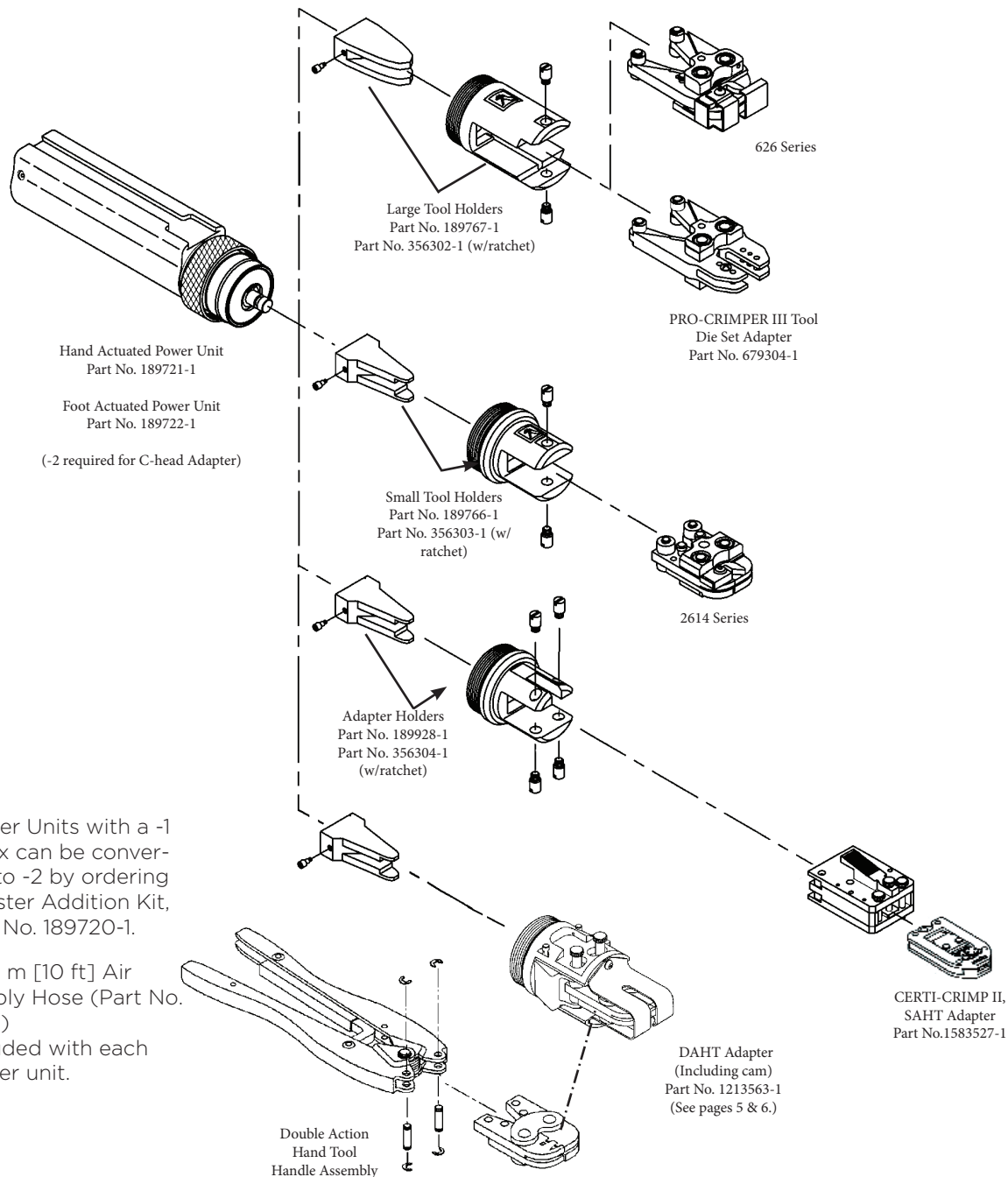

- Power Units with a -1 suffix can be converted to -2 by ordering Booster Addition Kit, Part No. 189720-1.
- 3.05 m [10 ft] Air Supply Hose (Part No. 38111) included with each power unit.

Tooling Solutions for Aerospace, Defense and Marine

Hydraulic Powered Crimp Tooling for 8,200 psi

FAST FACTS

- TE legacy 8,200 psi hydraulic system pumps and crimp heads
- Electric & manual hydraulic pumps for crimping at fixed locations
- 8,200 psi crimp heads compatible with shank dies available for wire sizes requiring a crimp force up to 33 tons
- U-die crimp head stroke options of 1" and 1.5"
- Hand-held pistol grip tools with rechargeable battery for U-dies
- Integrated crimp head/die combinations for crimping #8-2 AWG SOLISTRAND terminals



TE Connectivity's line of quality tooling TE legacy 8,200 psi [56,540 kPa] hydraulic tool systems. The basic hydraulic tool system requires a pump, hose (multiple lengths are available with all configurations), crimp head, and crimp die. There is a TE hydraulic pump to meet the demands of any crimping application. For fixed crimping locations, you can choose between a 110V or 220V Electric Hydraulic Pump (with optional remote hand control), or manual foot and hand hydraulic pumps.

For wire sizes requiring up to 33 tons [294 kN], TE offers crimp heads for 8,200 psi pumps that are compatible with shank dies. For an 8,200 psi hydraulic system, there are eight crimp heads available. These crimp heads accept shank dies. The crimp heads are available for wire sizes requiring up to 33 tons of crimp force.

For both hydraulic systems, an integrated head/die for crimping #8 to #2 SOLISTRAND terminals is available. There are also manual hand held hydraulic tools available for both U and shank die sets.

Note: 10,000 psi hydraulic pumps are not compatible with 8,200 psi crimp heads. 8,200 psi hydraulic pumps are not compatible with 10,000 crimp heads.

Tooling Solutions for Aerospace, Defense and Marine

Hydraulic Tooling Selection Guide - 56,540 kPa / 8,200 psi

Hydraulic Pumps, Controls and Hoses

The Heavy-duty Pump is designed for higher crimp cycle frequency.



WITH

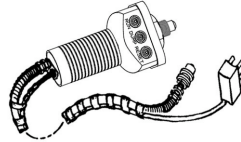

OR



AND



Heavy Duty Electric Hydraulic Pump (110V)^{1,2}
P/N 69120-1
 OR
 Heavy Duty Electric Hydraulic Pump (220V)^{1,2}
P/N 69120-2
 CM 409-1950

Remote Hand Control³
(for Heavy-Duty pump)
 w/hose attached
P/N 59907-7 (7 ft hose)
P/N 1-59907-5 (15 ft hose)
P/N 2-59907-1 (21 ft hose)

Remote Foot Control³
(for Heavy-Duty pump)
P/N 68284-1

Hydraulic Hoses⁴
(not required for hand control)
P/N 59909-3 (3 ft)
P/N 59909-7 (7 ft)
P/N 1-59909-5 (15 ft)
P/N 2-59909-1 (21 ft)

Heavy-Duty Crimp Heads (Shank Dies) (> 25,000 cycles)

Shank Dies



250 MCM - 600 MCM
 33 ton output force
 28 lbs
P/N 58445-1
 IS 408-9598



8 - 4/0 AWG
 22 ton output force
 16 lbs
P/N 69066
 IS 408-2453



4/0 AWG - 1000 MCM
 26 ton output force
 29 lbs
P/N 69082
 IS 408-2456



8 - 4/0 AWG
 33 ton output force
 28 lbs
P/N 58422-1
 IS 408-9535



12-10 AWG - 350 MCM
 18 ton output force
 13 lbs
P/N 69099
 IS 408-2458



PLASTI-GRIP	8 AWG - 4/0 AWG
AMPOWER	6 AWG - 1500 MCM
AMPOWER Quick Disconnect	1/0 AWG - 600 MCM
Insulation Piercing COPALUM	10 AWG (Cu) - 3/0 AWG
Sealed COPALUM	10 AWG - 3/0 AWG
Bar COPALUM	10 AWG (Cu) - 400 MCM
SOLISTRAND	8 AWG - 600 MCM
STRATO-THERM	8 AWG - 2/0 AWG
TERMINYL	1/0 AWG thru 4/0 AWG

Hydraulic Hand Tools

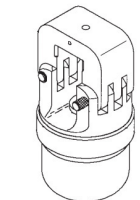

8 - 2 AWG
 8 ton output force
 5 lbs
P/N 69051
 IS 408-2450

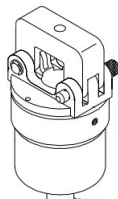

8 - 4/0 AWG
 12 ton output force
 10 lbs
P/N 69065
 IS 408-2452

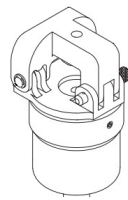

8 - 4/0 AWG
 12 ton output force
 10 lbs
P/N 69067
 IS 408-2454



8-4/0 AWG
 12.5 lbs
P/N 59973-1
 IS 408-6803

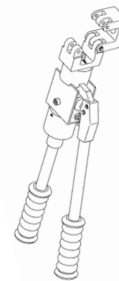

8-2 AWG
 8 lbs
P/N 59974-1
 IS 408-6757

- Powered systems require a pump, hand or foot control, hose, crimp head and die except with **69069**.
- Manual systems require hand tools and the battery hand tool requires only dies.

- Hand Pump **314979-1** can be substituted as manual options for Electro-Hydraulic Pumps.
- Includes female screw-to-connect, 3/8 NPT quick couplers.
- Not required with manual pump options.
- Includes male screw-to-connect, 3/8 NPT quick couplers.

SOLISTRAND (Integrated Crimp Dies)



#8-#2 AWG SOLISTRAND Compression Head
 (No crimp dies required)
P/N 69069
 IS 408-1745



#8-#2 AWG SOLISTRAND Compression Tool
 (No crimp dies required)
P/N 59975-1
 IS 408-6758

Tooling Solutions for Aerospace, Defense and Marine

Dies, Hand Tools and Hydraulic Heads Configuration Options

The TE Connectivity hydraulic crimping tool line offers a wide array of die, hand tool, and hydraulic head configurations. Use the following tables to determine the configuration that best matches your requirements.

SOLISTRAND Terminals



DYNA-CRIMP System 8,200 psi Operating Pressure						
Wire Size in AWG [mm ²]	Hand Tool	Hydraulic Heads	Hydraulic Heads (Shank Dies)			
		59973-1	69065 69067	69069 ▲	69099	58445-1
8 [7-8.5]	48126** 48355○	48126** 48355○	▲	69216		
6 [13-15]	48128** 48127○	48128** 48127○	▲	69217		
4 [21]	48129** 48127○	48129** 48127○	▲	69218		
2 [34-35]	48130** 48127○	48130** 48127○	▲	45433		
1/0 [50-60]	48132** 48131○	48132** 48131○		45436		
2/0 [67-70]	48133** 48131○	48133** 48131○		45439		
3/0 [80-95]	48134** 48131○	48134** 48131○		45442		
4/0 [100-125]	300430** 48131○	300430** 48131○		45445		
250-300 MCM [127-152]					48816	69911
300-350 MCM [152-177]					48817	69912
400 MCM [203]					48818	69913
500-600 MCM [253-304]					48819	69914

**	Stationary Die
○	Moving Die
▲	Self-Contained Die

Tooling Solutions for Aerospace, Defense and Marine

Dies, Hand Tools and Hydraulic Heads Configuration Options



Heavy Duty SOLISTRAND Terminals

Wire Size in AWG [mm ²]	DYNA-CRIMP System 8,200 psi Operating Pressure	
	Hand Tools (U-Die)	Hydraulic Heads (U-Die)
	59973-1	69065 69067
8 [7-8.5]	48128-1 ** 48127-1 ○	48128-1 ** 48127-1 ○
6 [13-15]	48129-1 ** 48127-1 ○	48129-1 ** 48127-1 ○
4 [21]	48130-1 ** 48127-1 ○	48130-1 ** 48127-1 ○
2 [34-35]	48132-1 ** 48131-1 ○	48132-1 ** 48131-1 ○
1/0 [50-60]	48133-1 ** 48131-1 ○	48133-1 ** 48131-1 ○

SOLISTRAND Flag Terminals



Wire Size in AWG [mm ²]	DYNA-CRIMP System 8,200 psi Operating Pressure
	Hydraulic Heads (U-Die)
	69067
8 [7-8.5]	48506 ** 48505 ○
6 [13-15]	48508 ** 48507 ○
4 [21]	48509 ** 48507 ○
2 [34-35]	48510 ** 48507 ○
1/0 [50-60]	48652 ** 48511 ○
2/0 [67-70]	48805 ** 48511 ○
3/0 [80-95]	48806 ** 48511 ○
4/0 [100-125]	48807 ** 48511 ○

**	Stationary Die
○	Moving Die

Tooling Solutions for Aerospace, Defense and Marine

Dies, Hand Tools and Hydraulic Heads Configuration Options

TERMINYL Terminals and Splices



Wire Size in AWG [mm²]	DYNA-CRIMP System 8,200 psi Operating Pressure			
	Hand Tool	Hydraulic Heads (Shank Die)		
	59974-1	69051	69066	58422-1
8 [7-8.5]	47820	47820		
6 [13-15]	47821	47821		
4 [21]	47822	47822		
4HD			69463	69463
2 [34-35]	47823	47823		
1/0 [50-60]			47824	47824
2/0 [67-70]			47825	47825
3/0 [80-95]			47915	47915
4/0 [100-125]			47918	47918

PLASTI-GRIP Terminals and Splices



Wire Size in AWG [mm²]	DYNA-CRIMP System 8,200 psi Operating Pressure			
	Hand Tool	Hydraulic Heads (Shank Die)		
	59974-1	69051	69066	58422-1
8 [7-8.5]	48752-1	48752-1	48858-1	48858-1
6 [13-15]	48753-1	48753-1	48859-1	48859-1
4 [21]	48754-1	48754-1	48860-1	48860-1
2 [34-35]	48755-1	48755-1	48861-1	48861-1
1/0 [50-60]			48756-1	48756-1
2/0 [67-70]			48757-1	48757-1
3/0 [80-95]			48758-1	48758-1
4/0 [100-125]			48759-1	48759-1

Tooling Solutions for Aerospace, Defense and Marine

Dies, Hand Tools and Hydraulic Heads Configuration Options

STRATO-THERM Terminals and Splices



Wire Size in AWG [mm ²]	DYNA-CRIMP System 8,200 psi Operating Pressure	
	Hydraulic Head (Shank Die)	
	69099	
8 [7-8.5]	69211-1	
6 [13-15]	69212-1	
4 [21]	69213-1	
2 [34-35]	69214-1	
1/0 [50-60]	69215-1	
2/0 [67-70]	69254-1	

AMPOWER Quick Disconnect Terminals



Wire Size in AWG [mm ²]	DYNA-CRIMP System 8,200 psi Operating Pressure	
	Hydraulic Heads (Shank Die)	
	69099	69082
1/0 [50-60]	68361-1 ○ / 68200-1	
2/0 [67-70]	68253-1 ○ / 68201-1	
3/0 [80-95]	59867-1 ○	
4/0 [100-125]	68304-1 ○	
250 MCM [127]	68203-1	
350 MCM [177]		68204-1
400 MCM [203]		68332-1 ●
500 MCM [253]		68206-●
600 MCM [304]		46757-3

○	With Locator
●	Dual Crimp

Tooling Solutions for Aerospace, Defense and Marine

Dies, Hand Tools and Hydraulic Heads Configuration Options

AMPOWER Terminals and Splices



Wire Size in AWG [mm²]	DYNA-CRIMP System 8,200 psi Operating Pressure				
	Hand Tool	Hydraulic Heads (Shank Die)			
	59973-1	69065 69067	69099	58445-1	69082
6 [13-15]			69133-1		
4 [21]			69134-2		
2 [34-35]	46321-3	46321-3	46765-3		
1/0 [50-60]	46322-2	46322-2	46766-2		
2/0 [67-70]	46323-2	46323-2	46767-2		
3/0 [80-95]	46324-2	46324-2	46749-2		
4/0 [100-125]	46325-2	46325-2	46750-2		
250 MCM [127]			46751-2	46326-2	
300 MCM [152]			46752-2		
350 MCM [177]			46753-2		69653
400 MCM [203]					46754-2
500 MCM [253]					46755-2
600 MCM [304]					46756-2
600 HD					59870-1
700 MCM [355]					46757-2
800 MCM [405]					46758-2
900 MCM [456]					46759-2
1000 MCM [507]					46760-2

Tooling Solutions for Aerospace, Defense and Marine

Dies, Hand Tools and Hydraulic Heads Configuration Options



Sealed Crimp COPALUM Terminals and Splices

Wire Size in AWG [mm ²]		DYNA-CRIMP System 8,200 psi Operating Pressure	
		Hydraulic Heads (Shank Die)	
Al	Cu		
8 [7-8.5]	10 [5-6]	69066	58422-1
8 [7-8.5]	10 [5-6]	68006	68006
6 [13-15]	8 [7-8.5]	68007	68007
4 [21]	6 [13-15]	68008	68008
2 [34-35]	4 [21]	68009	68009
1/0 [50-60]	2 [34-35]	68010	68010
2/0 [67-70]	1/0 [50-60]	314964-1	68011-1
3/0 [80-95]	2/0 [67-70]		59877-1
4/0 [100-125]	3/0 [80-95]		314948-1



Bar Crimp COPALUM Terminals and Splices

Wire Size in AWG [mm ²]		DYNA-CRIMP System 8,200 psi Operating Pressure	
		Hydraulic Heads (Shank Die)	
Al	Cu		
8 [7-8.5]	10 [5-6]	69099	69082
8 [7-8.5]	10 [5-6]	68043	
6 [13-15]	8 [7-8.5]	68044	
4 [21]	6 [13-15]	68045	
2 [34-35]	4 [21]	68046	
1/0 [50-60]	2 [34-35]	68047	
2/0 [67-70]	1/0 [50-60]	68048	
3/0 [80-95]	2/0 [67-70]	68049	
4/0 [100-125]	3/0 [80-95]		68050
250 MCM [127]	4/0 [100-125]		68034
300 MCM [152]	250 MCM [127]		68035
400 MCM [203]	300 MCM [152]		68036
500 MCM [253]	400 MCM [203]		68037

Tooling Solutions for Aerospace, Defense and Marine

Dies, Hand Tools and Hydraulic Heads Configuration Options

Insulation Piercing Crimp COPALUM Terminals and Splices

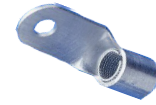

Wire Size in AWG [mm²]		DYNA-CRIMP System 8,200 psi Operating Pressure	
		Hydraulic Heads (Shank Die)	
Al	Cu	69099	69082
8 [7-8.5]	10 [5-6]	68084	
6 [13-15]	8 [7-8.5]	68085	
4 [21]	6 [13-15]	68086	
2 [34-35]	4 [21]	68130	
1/0 [50-60]	2 [34-35]	68131	
2/0 [67-70]	1/0 [50-60]	68132	
3/0 [80-95]	2/0 [67-70]	68133	
4/0 [100-125]	3/0 [80-95]	318106-1	68129

Hydraulic Equipment Options for 56,540 kPa / 8,200 psi

Hydraulic Hand Pump, manual

PN **314979-1**



3-Way Multidirectional Valve

PN **59920** (manual)



Tooling Solutions for Aerospace, Defense and Marine

Selecting a Hydraulic System?

Have you remembered a ...

- Pump
- Hand or foot control
- Hose
- Crimp head
- Crimp die

Hydraulic Tooling Selection Guide - 70,000 kPa / 10,000 psi

Pump and Hose Options

The heavy-duty pump is designed for continuous use.

Heavy duty electric hydraulic pump



110 V^{1,2} PN 1804700-1
220 V^{1,2} PN 1804700-2

Hydraulic hoses³



PN 1583662-1 – 1.8 m / 6 ft
PN 1583662-2 – 3.0 m / 10 ft
PN 1583662-3 – 6.1 m / 20 ft

WITH

Heavy-Duty Crimp Heads (Shank Dies)(> 25,000 cycles)



8 - 4/0 A
22 t output force 16 lbs
PN 1752877-1
IS 408-8956



4/0 AWG-1000 MCM
26 t output force 29 lbs
PN 1752786-1
IS 408-8958



8 - 4/0 AWG
33 t output force 28 lbs
PN 1752787-1
IS 408-8914



12-10 AWG - 350 MCM
18 t output force 13 lbs
PN 1752868-1
IS 408-8959



AMPOWER	6 AWG-1500 MCM
AMPOWER quick disconnect	1/0 AWG-600 MCM
Insulation piercing COPALUM	10 AWG (Cu)-3/0 AWG
Sealed COPALUM	10 AWG-3/0 AWG
Bar COPALUM	10 AWG (Cu)-400 MCM
SOLISTRAND	8 AWG-600 MCM
STRATO-THERM	8 AWG-2/0 AWG
TERMINYL	1/0 AWG thru 4/0 AWG

Shank Dies

Medium-Duty Crimp Heads & Hand Tools (U-Dies)



14 t output force
1.5" stroke;
crimp head

U-die compatible
PN 1490746-1
IS 408-10112



12 t output force
1" stroke crimp head

U-die compatible
PN 1490745-1
PN 1490747-1 (titanium)
IS 408-8715



14 t output force
1.5" stroke heavy-duty
crimp head

U-die compatible
PN 1976230-1
IS 408-10145



14 t output force 1.5"
stroke
crimp tool

U-die compatible
PN 1490749-1
IS 408-8717



1" stroke hand
crimp tool

U-die compatible
PN 1490748-1
IS 408-8716



U-Dies

AMPOWER	6 AWG - 4/0 AWG
SOLISTRAND	8 AWG - 4/0 AWG
TERMINYL	8 AWG - 1/0 AWG

- ¹ Foot pump 523199-2 OR Hand pump 1583661-1 can be substituted as manual options for electro-hydraulic pumps
- ² Includes male screw-to-connect, ³/₈" NPT quick couplers
- ³ Includes female screw-to-connect, ³/₈" NPT quick couplers

SOLISTRAND (Integrated Crimp Dies)



#8-#2 AWG SOLISTRAND crimp head
(no crimp dies required)
PN 1673672-1 / IS 408-8910



#8-#2 AWG SOLISTRAND crimp tool
(no crimp dies required)
PN 59975-1 / IS 408-6758

Tooling Solutions for Aerospace, Defense and Marine

Dies, Hand Tools and Hydraulic Heads Configuration Options

The TE Connectivity hydraulic crimping tool line offers a wide array of die, hand tool, and hydraulic head configurations.

Use the following tables to determine the configuration that best matches your requirements.

The tables are color-coded to help you identify the 68,950 kPa [10,000 psi] rated configurations that correspond to previous 56,540 kPa [8,200 psi] tooling.

TERMINYL Terminals and Splices

Wire Size in AWG [mm ²]	Hydraulic Crimp Tooling 10,000 psi Operating Pressure					
	Hand Tools (U-Die)		Hydraulic Heads (U-Die)		Hydraulic Heads (Shank-Die)	
	1490748-1	1490749-1	1490745-1 1490747-1	1490746-1 1976230-1	1752877-1	1752787-1
8 [7-8.5]	1490597-1	1490597-1	1490597-1	1490597-1		
6 [13-15]	1490598-1	1490598-1	1490598-1	1490598-1		
4 [21]	1490599-1	1490599-1	1490599-1	1490599-1		
4HD					69463	69463
2 [34-35]		1490406-1		1490406-1		
1/0 [50-60]		1490700-1		1490700-1	47824	47824
2/0 [67-70]					47825	47825
3/0 [80-95]					47915	47915
4/0 [100-125]					47918	47918

PLASTI-GRIP Terminals and Splices

Wire Size in AWG [mm ²]	Hydraulic Crimp Tooling 10,000 psi Operating Pressure			
	Hand Tool (U-Die)	Hydraulic Head (U-Die)	Hydraulic Heads (Shank Die)	
	1490749-1	1490746-1 1976230-1	1752877-1	1752787-1
8 [7-8.5]	1490534-1	1490534-1	48858-1	48858-1
6 [13-15]	1490535-1	1490535-1	48859-1	48859-1
4 [21]	1490536-1	1490536-1	48860-1	48860-1
2 [34-35]	1490410-1	1490410-1	48861-1	48861-1
1/0 [50-60]			48756-1	48756-1
2/0 [67-70]			48757-1	48757-1
3/0 [80-95]			48758-1	48758-1
4/0 [100-125]			48759-1	48759-1

Tooling Solutions for Aerospace, Defense and Marine

Dies, Hand Tools and Hydraulic Heads Configuration Options

PLASTI-GRIP Large Expansion Terminals

Wire Size in AWG [mm ²]	Hydraulic Crimp Tooling 10,000 psi Operating Pressure		□	Stationary die	
	Hydraulic Heads (Shank Die)			**	Moving die
	1752877-1	1752787-1		+	Self-Contained die
8 [7-8.5]	47236-1	47236-1	◇	Use adapter 69760	
6 [13-15]	47237-1	47237-1	×	Use adapter 69834	
4 [21]	47238-1	47238-1			
2 [34-35]	47239-1	47239-1			
1/0 [50-60]	47378-1	47378-1			

SOLISTRAND Terminals

Hydraulic Crimp Tooling 10,000 psi Operating Pressure							
Wire Size in AWG [mm ²]	Hand Tool (Dies Included)	Hand Tools (U-Die)	Hydraulic Heads (U-Die)	Hydraulic Heads (Shank Die)			
	59975-1 +	1490748-1 1490749-1	1490745-1 1490746-1 1490747-1 1976230-1	673672-1 +	1752868-1	1752788-1	1752786-1
8 [7-8.5]	+	1490413-1 □ 1490414-1 **	1490413-1 □ 1490414-1 **	+	69216		
6 [13-15]	+	1490413-2 □ 1490414-2 **	1490413-2 □ 1490414-2 **	+	69217		
4 [21]	+	1490413-3 □ 1490414-2 **	1490413-3 □ 1490414-2 **	+	69218		
2 [34-35]	+	1490413-4 □ 1490414-2 **	1490413-4 □ 1490414-2 **	+	45433		
1/0 [50-60]		1490413-5 □ 1490414-3 **	1490413-5 □ 1490414-3 **		45436		
2/0 [67-70]		1490413-6 □ 1490414-3 **	1490413-6 □ 1490414-3 **		45439		
3/0 [80-95]		1490413-7 □ 1490414-3 **	1490413-7 □ 1490414-3 **		45442		
4/0 [100-125]		1490413-8 □ 1490414-3 **	1490413-8 □ 1490414-3 **		45445		
250-300 MCM [127-152]						48816	69911
300-350 MCM [152-177]						48817	69912
400 MCM [203]						48818	69913
500-600 MCM [253-304]						48819	69914

Tooling Solutions for Aerospace, Defense and Marine

Dies, Hand Tools and Hydraulic Heads Configuration Options

Heavy Duty SOLISTRAND Terminals

Wire Size in AWG [mm²]	Hydraulic Crimp Tooling 10,000 psi Operating Pressure	
	Hand Tools (U-Die)	Hydraulic Heads (U-Die)
		1490748-1 1490749-1
8 [7-8.5]	1490413-9 □ 1490413-2 *	1490413-9 □ 1490414-2 *
6 [13-15]	1-1490413-0 □ 1490414-2 *	1-1490413-0 □ 1490414-2 *
4 [21]	1-1490413-1 □ 1490414-2 *	1-1490413-1 □ 1490414-2 *
2 [34-35]	1-1490413-2 □ 1490414-3 *	1-1490413-2 □ 1490414-3 *
1/0 [50-60]	1-1490413-3 □ 1490414-3 *	1-1490413-3 □ 1490414-3 *

SOLISTRAND Flag Terminals

Wire Size in AWG [mm²]	Hydraulic Crimp Tooling 10,000 psi Operating Pressure		
	Hand Tools (U-Die)	Hydraulic Heads (U-Die)	Hand Tool (Shank Die)
		1490749-1	1490746-1 1976230-1
8 [7-8.5]	1752680-8 □ 1752681-2 *	1752680-8 □ 1752681-2 *	48506-1 □◇ 48505-1 **×
6 [13-15]	1752680-7 □ 1752681-3 *	1752680-7 □ 1752681-3 *	48508-1 □◇ 48507-1 **×
4 [21]	1752680-6 □ 1752681-3 *	1752680-6 □ 1752681-3 *	48509-1 □◇ 48507-1 **×
2 [34-35]	1752680-5 □ 1752681-3 *	1752680-5 □ 1752681-3 *	48510-1 □◇ 48507-1 **×
1/0 [50-60]	1752680-4 □ 1752681-1 *	1752680-4 □ 1752681-1 *	48652-1 □◇ 48511-1 **×
2/0 [67-70]	1752680-3 □ 1752681-1 *	1752680-3 □ 1752681-1 *	48805-1 □◇ 48511-1 **×
3/0 [80-95]	1752680-2 □ 1752681-1 *	1752680-2 □ 1752681-1 *	48806-1 □◇ 48511-1 **×
4/0 [100-125]	1752680-1 □ 1752681-1 *	1752680-1 □ 1752681-1 *	48807-1 □◇ 48511-1 **×

□	Stationary Die
*	Moving Die
+	Self-Contained Die
◇	Use Adapter 69760
×	Use Adapter 69834

Tooling Solutions for Aerospace, Defense and Marine

Dies, Hand Tools and Hydraulic Heads Configuration Options

AMPOWER Quick Disconnect Terminals

Wire Size in AWG [mm ²]	Hydraulic Crimp Tooling 10,000 psi Operating Pressure	
	Hydraulic Heads (Shank Die)	
	1752868-1	1752786-1
1/0 [50-60]	68361-1 ● / 68200-1	
2/0 [67-70]	68253-1 ● / 68201-1	
3/0 [80-95]	59867-1 ●	
4/0 [100-125]	68304-1 ●	
250 MCM [127]	68203-1	
350 MCM [177]		68204-1
400 MCM [203]		68332-1 ≈
500 MCM [253]		68206-1 ≈
600 MCM [304]		46757-3

●	With locator
≈	Dual Crimp

Insulation Piercing Crimp COPALUM Terminals and Splices

Wire Size in AWG [mm ²]		Hydraulic Crimp Tooling 10,000 psi Operating Pressure			
		Hand Tool (U-Die)	Hydraulic Head (U-Die)	Hydraulic Heads (Shank Die)	
Al	Cu			1752868-1	1752786-1
8 [7-8.5]	10 (5-6)	1490749-1	1490746-1 1976230-1	68084	
6 [13-15]	8 [7-8.5]	1490714-1	1490714-1	68085	
4 [21]	6 [13-15]	1490715-1	1490715-1	68086	
2 [34-35]	4 [21]	1490716-1	1490716-1	68130	
1/0 [50-60]	2 [34-35]	1490717-1	1490717-1	68131	
2/0 [67-70]	1/0 [50-60]	1490718-1	1490718-1	68132	
3/0 [80-95]	2/0 [67-70]			68133	
4/0 [100-125]	3/0 [80-95]			318106-1	68129

Tooling Solutions for Aerospace, Defense and Marine

Dies, Hand Tools and Hydraulic Heads Configuration Options

AMPOWER Terminals and Splices

Wire Size in AWG [mm ²]	Hydraulic Crimp Tooling 10,000 psi Operating Pressure						
	Hand Tools (U-Die)		Hydraulic Heads (U-Die)		Hydraulic Heads (Shank Die)		
	1490748-1	1490749-1	1490745-1 1490747-1	1490746-1 1976230-1	1752868-1	1752788-1	1752786-1
6 [13-15]	1583092-1	1583092-1	1583092-1	1583092-1	69133-1		
4 [21]	1583093-1	1583093-1	1583093-1	1583093-1	69134-2		
2 [34-35]	1583094-1	1583094-1	1583094-1	1583094-1	46765-3		
1/0 [50-60]	1583095-1	1583095-1	1583095-1	1583095-1	46766-2		
2/0 [67-70]	1583096-1	1583096-1	1583096-1	1583096-1	46767-2		
3/0 [80-95]				◆1583097-1	46749-2		
4/0 [100-125]				◆1583098-1	46750-2		
250 MCM [127]					46751-2	46326-2	
300 MCM [152]					46752-2		
350 MCM [177]					46753-2		69653
400 MCM [203]							46754-2
500 MCM [253]							46755-2
600 MCM [304]							46756-2
600 HD							59870-1
700 MCM [355]							46757-2
800 MCM [405]							46758-2
900 MCM [456]							46759-2
1000 MCM [507]							46760-2
1250 MCM [634]							
1500 MCM [761]							

◆	1976230-1 only
---	----------------

Tooling Solutions for Aerospace, Defense and Marine

Dies, Hand Tools and Hydraulic Heads Configuration Options

Sealed Crimp COPALUM Terminals and Splices

Wire Size in AWG [mm ²]		Hydraulic Crimp Tooling 10,000 psi Operating Pressure			
		Hand Tool (U-Die)	Hydraulic Head (U-Die)	Hydraulic Heads (Shank Die)	
Al	Cu	1490749-1	1490746-1 1976230-1	1752877-1	1752787-1
8 [7-8.5]	10 (5-6)	1490555-1	1490555-1	68006	68006
6 [13-15]	8 [7-8.5]	1490556-1	1490556-1	68007	68007
4 [21]	6 [13-15]	1490557-1	1490557-1	68008	68008
2 [34-35]	4 [21]			68009	68009
1/0 [50-60]	2 [34-35]			68010-1	68010-1
2/0 [67-70]	1/0 [50-60]			314964-1	68011-1
3/0 [80-95]	2/0 [67-70]				59877-1
4/0 [100-125]	3/0 [80-95]				314948-1

Bar Crimp COPALUM Terminals and Splices

Wire Size in AWG [mm ²]		Hydraulic Crimp Tooling 10,000 psi Operating Pressure			
		Hand Tool (U-Die)	Hydraulic Head (U-Die)	Hydraulic Heads (Shank Die)	
Al	Cu	1490749-1	1490746-1 1976230-1	1752868-1	1752786-1
8 [7-8.5]	10 [5-6]	1490572-1	1490572-1	68043	
6 [13-15]	8 [7-8.5]	1490573-1	1490573-1	68044	
4 [21]	6 [13-15]	1490574-1	1490574-1	68045	
2 [34-35]	4 [21]	1490575-1	1490575-1	68046	
1/0 [50-60]	2 [34-35]			68047	
2/0 [67-70]	1/0 [50-60]			68048	
3/0 [80-95]	2/0 [67-70]			68049	
4/0 [100-125]	3/0 [80-95]				68050
250 MCM [127]	4/0 [100-125]				68034
300 MCM [152]	250 MCM [127]				68035
400 MCM [203]	300 MCM [152]				68036
500 MCM [253]	400 MCM [203]				68037

Tooling Solutions for Aerospace, Defense and Marine

Dies, Hand Tools and Hydraulic Heads Configuration Options

STRATO-THERM Terminals and Splices

Wire Size in AWG	Wire Size in mm ²	Hydraulic Crimp Tooling 10,000 psi Operating Pressure
		Hydraulic Head (Shank Die)
		1752868-1
8	7-8.5	69211-1
6	13-15	69212-1
4	21	69213-1
2	34-35	69214-1
1/0	50-60	69215-1
2/0	67-70	69254-1

Tooling Solutions for Aerospace, Defense and Marine

Hydraulic Equipment Options and More Detailed Information for 70,000 kPa / 10,000 psi



Battery-Hydraulic Tool Kit 12 t U-Die

110 V PN 2280308-1
220 V PN 2280308-2

- Complete kit with battery charger
- Suitable for all 'U' dies with the exception of U-die assembly (14 t)
- Rotating head 320°
- Excellent power to weight ratio

Kit includes:

- Crimp tool
- Battery charger 110 V PN 217331-1
Battery charger 220 V PN 2217331-2
- Rechargeable battery PN 2280309-1
- Carry case with strap



Electric Hydraulic Pumps, Heavy Duty

110 V PN 1804700-1
220 V PN 1804700-2

suitable for continuous use

- Two speed cycle reduces cycle time for improved productivity
- Pump shuts down after pressure-switch setting is reached
- Easy to read integrated oil level sight glass
- Totally enclosed fan-cooled motor - ideal for use in any environment
- Quiet operation 70-79 dB(A)
- Swivel wheels provide easy manoeuvrability



Hydraulic Hand Pump, Manual

PN 1583661-1

This pump action unit allows hydraulic heads via optional length hydraulic hoses a degree of positional flexibility.



Hydraulic Foot Pump, Manual

PN 523199-2

- Pump action operation
- Clicker valve pressure regulation
- Supplied with male quick-coupling

3-Way Multidirectional Valve

PN 1901782-1 (manual)



Tooling Solutions for Aerospace, Defense and Marine

2 Application Tooling Global Services

2.1 Field Engineering Organization

TE Connectivity provides global field service support on our application tooling. Field Specialists are located across every continent to provide timely response to customer needs.

In addition to installation, warranty, and repair service, TE field specialists can help you with tooling choices, training of maintenance and operation personnel, troubleshooting and spare parts. Service contracts to cover all your application tooling needs are also available.

We have implemented a service management tool that provides standardization of reporting that gives us the ability to continuously improve our global service organization. Throughout the year we educate our field service engineers on the latest industry technologies and tooling solutions.

Service Offerings:

Standard Service

Includes troubleshooting issues, making repairs, and/or installing parts.

Machine Installations

Providing installation, set-up, and training of application tooling at the time of delivery.

Training

Providing customers with practical training programs addressing machine operation, set-up, maintenance, inspection, and connector application. Training programs can be scheduled at the customer's site or at a TE Connectivity training center. A training certificate will be issued upon the completion of each formal training course.

We are proud to be able to offer a comprehensive range of customer training programs.

The following are some of the standard training programs we offer:

Service Contracts

Preventive Maintenance and/or Inspection Certification

Provides service for periodic visits to perform preventive maintenance and/or inspection certification service on hand tools, applicators, bench and automatic machines.

Comprehensive Service

Provides for a specified number of field specialist visits. A visit can be used for services such as standard service, installation, set-up and training for all application tooling, preventive maintenance and/or inspection certification, spare parts management, tooling process evaluation, and technical assistance on application tooling and/or product related issues or concerns.

Tooling Solutions for Aerospace, Defense and Marine

2.2 Factory-Level Service, Certification and Tool Repair

The Key to Crimp Performance

You've already made the right choice in crimp tooling - TE Connectivity quality tooling. TE Connectivity quality certification and maintenance are also the right choices to keep your crimp tooling operating at peak performance. In this catalog you'll find details on the most popular services available at TE Connectivity service centers, complementing our on-site services. To request more information or to schedule a service, refer to the contact information on last cover page.

Applicator and Terminator Service

Services include:

- Warranty services - with no charge for labor or parts
- Certification services
- Tooling repair - to application specifications
- Quick turnaround
- 90-day warranty on repairs

Hand Tool Repair and Certification

CERTI-CRIMP hand tools and die sets; pneumatic crimping heads and die sets; and hydraulic hand tools, crimping heads, and die sets all benefit from factory or on-site service.

Services include:

- Recertification - promotes quality improvement per ISO 9000. Recommended every 6 months or 5,000 cycles to verify that tools meet TE Connectivity's application specification.
- Visual inspection - checks tool operation and looks for missing or damaged parts.
- Handle pressure check - measures pressure with calibrated machine or gauge; adjusts to match design specification.
- Quality inspection plan (QIP)
- 90-day warranty on repairs



Periodic maintenance, including recalibration, helps ensure compliance with specifications.



Handle force, measured at the factory, is a critical component of precise, reliable crimping.

Tooling Solutions for Aerospace, Defense and Marine

3 Appendix - Useful Information

3.1 Wire Range Limits

A reliable termination includes: Good electrical performance, cross-sectional area reduction and mechanical strength.

Termination quality is determined by measuring the crimp height of the crimped terminal. The proper crimp height, accompanied by careful visual inspection, assures that the termination will meet or exceed specified requirements, provided that the wire and tooling being used are correct.

A quality termination occurs when the terminal is crimped within the crimp design range.

Mechanical Strength and Electrical Performance Related to Crimping Force and the Cross-Sectional Area of Reduction

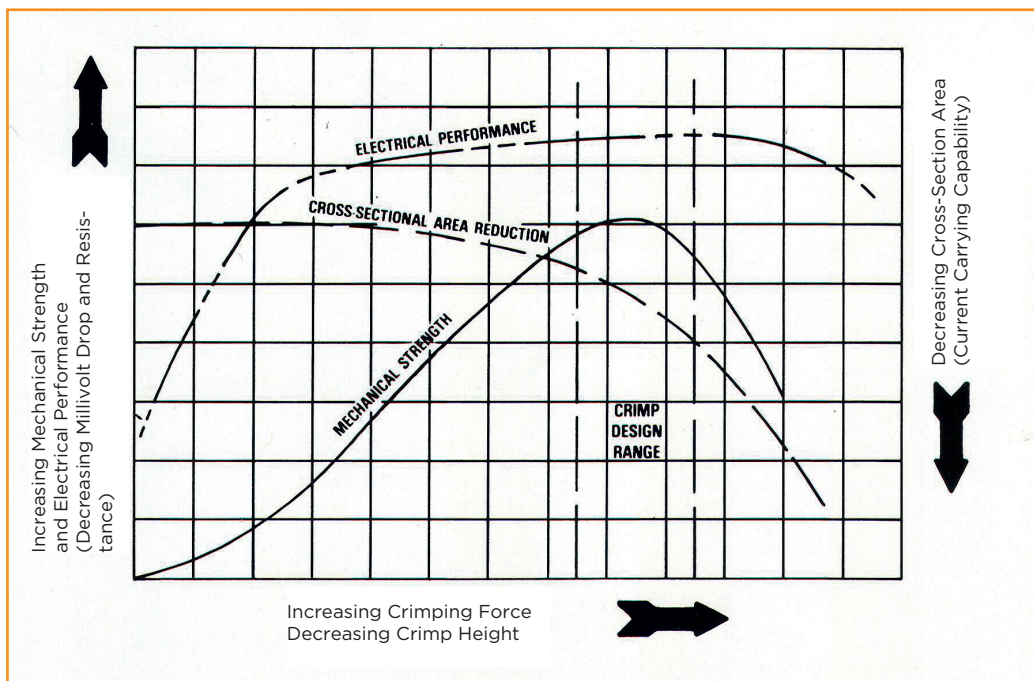

Tooling Solutions for Aerospace, Defense and Marine

3.2 How to Compute Circular Mil Area of Various Wire Shapes

Square or Rectangular Wire

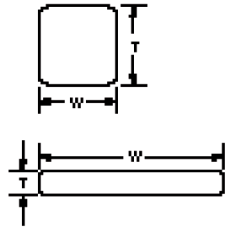

U.S. Customary Dimensions

Multiply the width of the wire cross section in mils by the thickness of the wire cross section in mils by 1.2732 and subtract the radius factor shown below.

$$CMA = W \times T \times 1.2732 - \text{radius factor}$$

Metric Dimensions

Multiply the width of the wire cross section in millimetres by the thickness of the wire cross section in millimetres by 1973.525 and subtract the radius factor shown below.

$$CMA = W \times T \times 1973.525 - \text{radius factor}$$

Round Solid Wire AWG

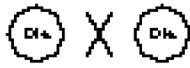

Multiply the diameter in mils by itself.

$$CMA = D^2$$

Multiply the diameter in millimetres by itself by 1550.003

$$CMA = D^2 \times 1550.003$$

Stranded Wire AWG

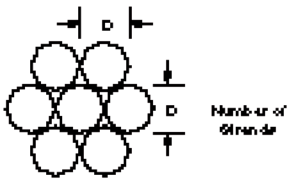

Multiply the diameter of one strand (in mils) by itself, and then multiply the result by the total number of strands.

$$CMA = D^2 \times N$$

Multiply the diameter of one strand in millimetres by itself by the number of strands by 1550.003.

$$CMA = D^2 \times N \times 1550.003$$

Conversion Table

To Convert From	To	Multiply By
CMA	mm ²	.0005067075
CMA	in ²	.0000007854
mm ²	in ²	.001550003
mm ²	CMA	1973.525

Note: Refer to table listing for circular mil area for common wire sizes.

Radius Factor, U.S. Customary

Radius (in.)	Radius Factor To Subtract (CMA)
.010	110
.012	158
.016	280
.020	438
.026	740
.032	1121
.040	1752
.063	4346
.094	9675

Radius must be measured.

Radius Factor, Metric

Radius (mm)	Radius Factor To Subtract (CMA)
0.25	106
0.3	153
0.35	208
0.4	272
0.5	424
0.6	611
0.8	1086
1.2	2444

Radius must be measured.

Table of SOLISTRAND and Budget Standard Wire Ranges

Use to select the proper size terminals or splices.

Terminal Connector Size	CMA Range
26-22	202-810
24-20	320-1,290
22-16	509-3,260
16-14 & 16-14 HD	2,050-5,180
14-12	3,260-8,230
12-10	5,180-13,100
8 & 8 HD	13,100-20,800
6 & 6 HD	20,800-33,100
4 & 4 HD	33,100-52,600

HD-Denotes Heavy Duty Terminal.

Terminal Connector Size	CMA Range
2 & 2 HD	52,600-83,700
1/0 & 1/0 HD	83,700-119,500
2/0	119,500-150,500
3/0	150,500-190,000
4/0	190,000-231,000
250-300 MCM	231,000-300,000
300-350 MCM	300,000-380,000
400 MCM	350,000-478,000
500-600 MCM	478,000-600,000

Tooling Solutions for Aerospace, Defense and Marine

3.3 Wire Range and Color Codes

The wire range stamped on a terminal indicates the smallest and largest acceptable single wire. When two or more wires are used, the total cross-sectional area should be within the range listed in the CMA range column.

INSULATED				UNINSULATED			
TERMINAL SIZE	PRODUCT COLOR CODE* PIDG, PLASTI-GRIP AMPLI-BOND, TERMINYL	CMA RANGE@	CRIMP CODE ††	TERMINAL SIZE	CMA RANGE	CRIMP CODE ††	
						AMPOWER	SOLISTRAND
26-22	YELLOW	202-810	●	22-16	509-3,260	↑	↑
				16-14	2,050-5,180		
24-20	WHITE OR TRANSLUCENT	320-1,290	●●	16-14 HD†	2,050-5,180		
				14-12	3,260-8,230		
22-16 22-18 (MIL)	RED	509-3,260	●	12-10	5,180-13,100		
				8	13,100-20,800		
20-16 HD†	GREEN	992-2,800	●●	6	20,800-33,100		
				4	33,100-52,600		
16-14	BLUE	2,050-5,180	●●	2	52,600-83,700		
				1/0	83,700-119,500		
16-14 HD†	YELLOW OR BLACK‡	2,050-5,180	●	2/0	119,500-150,500		
				3/0	150,500-190,000		
12-10	YELLOW	5,180-13,100	●	4/0	190,000-231,000		
				250-300 MCM	231,000-300,000		
8	RED	13,100-20,800	EMBOSSSED 8	300-350 MCM	300,000-380,000		
				400 MCM	380,000-478,000		
6	BLUE	20,800-33,100	EMBOSSSED 6	500-600 MCM	478,000-600,000		
				250 MCM	231,000-275,000		
4	YELLOW	33,100-52,600	EMBOSSSED 4	300 MCM	275,000-325,000		
				350 MCM	325,000-375,000		
2	RED	52,600-83,700	EMBOSSSED 2	400 MCM	375,000-450,000		
				500 MCM	450,000-550,000		
1/0	BLUE	83,700-119,500	EMBOSSSED 1/0	600 MCM	550,000-650,000		
				700 MCM	650,000-750,000		
2/0	YELLOW	119,500-150,500	EMBOSSSED 2/0	800 MCM	750,000-850,000		
				900 MCM	850,000-950,000		
3/0	RED	150,500-190,000	EMBOSSSED 3/0	1000 MCM	950,000-1,125,000		
				1250 MCM	1,125,000-1,300,000		
4/0	BLUE	190,000-231,000	EMBOSSSED 4/0	1500 MCM	1,300,000-1,600,000		

† CRIMP WITH NEXT LARGER SIZE TOOLING.

‡ BLACK CODING USED FOR PRE-INSULATED FLAGS.

* THERE ARE EXCEPTIONS.

†† EMBOSSSED ON CRIMPED TERMINAL OR SPLICE.

@ NOT APPLICABLE TO MILITARY SPECIFICATIONS.

Tooling Solutions for Aerospace, Defense and Marine

Wire Range and Color Codes

SOLISTRAND Terminal Uninsulation Support Sleeve / Size 26 to 600 MCM

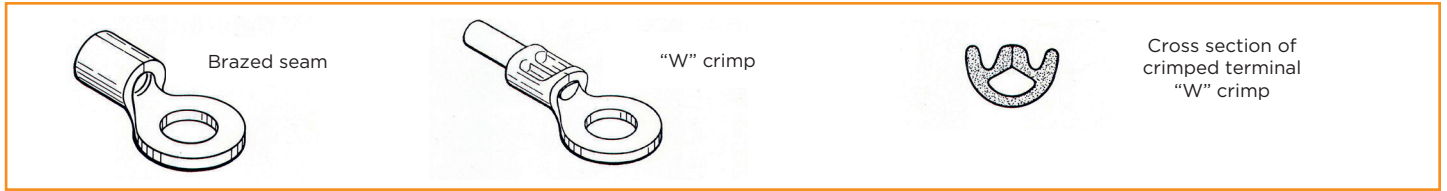

DIAMOND GRIP Uninsulated Terminal with Metal Insulation Support Sleeve / Size 26 to 10



PIDG Terminal Insulated with Metal Insulation Support Sleeve / Size 26 to 10

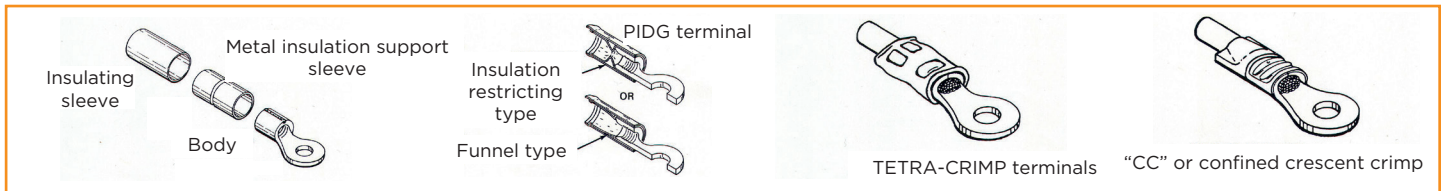

PLASTI-GRIP Terminal Insulated with Insulation Support / Size 22 to 2/0

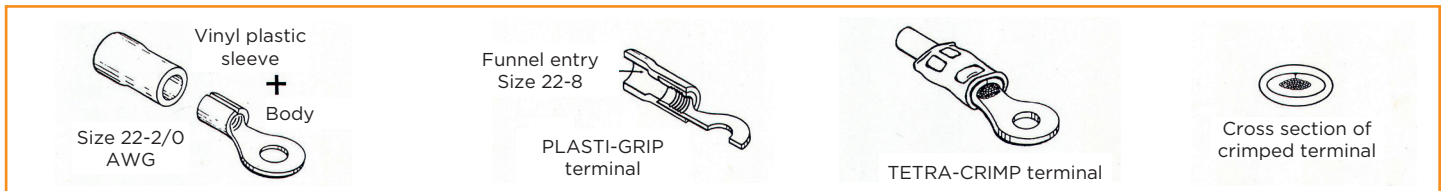

TERMINYL Terminal Nylon Insulated / Size 8 to 4/0

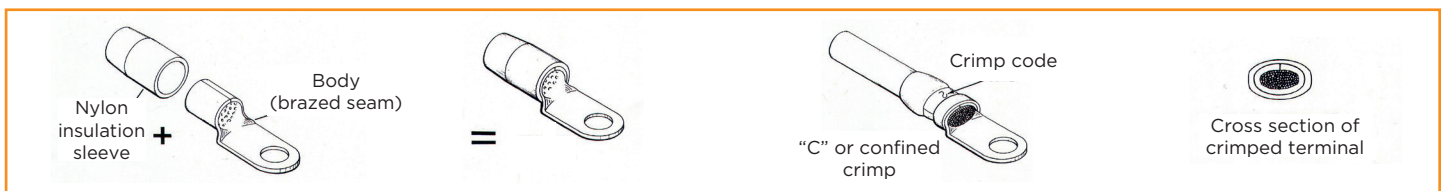

Tooling Solutions for Aerospace, Defense and Marine

Wire Range and Color Codes

AMPOWER Terminal Uninsulated

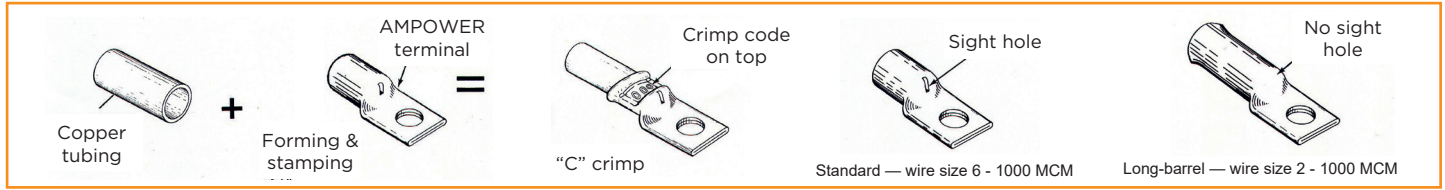

STRATO-THERM Terminal Uninsulated

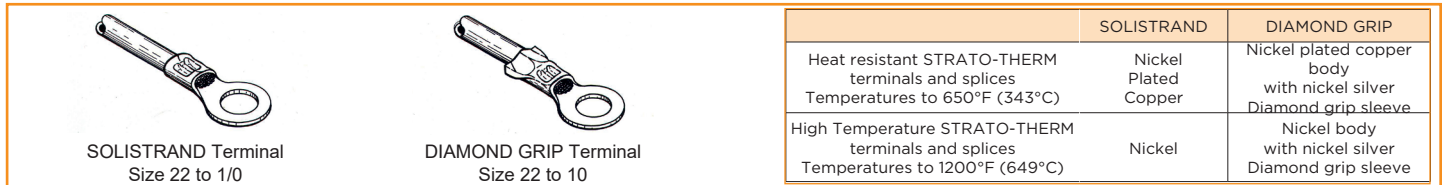

PIDG STRATO-THERM Terminal Insulated with Metal Insulation Support Sleeve / Size 26 to 10

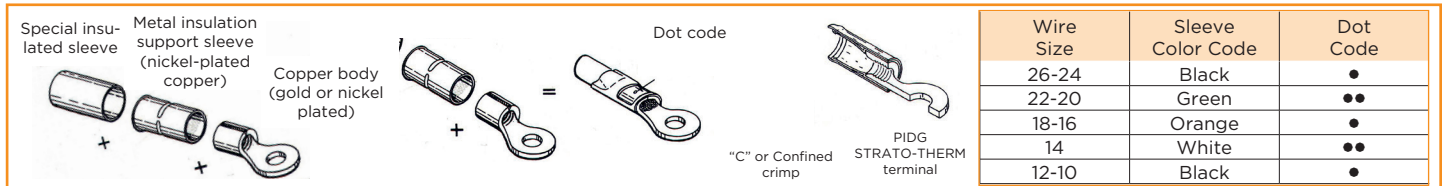

PIDG Terminal Insulation-Restricting Size 26 to 10 AWG

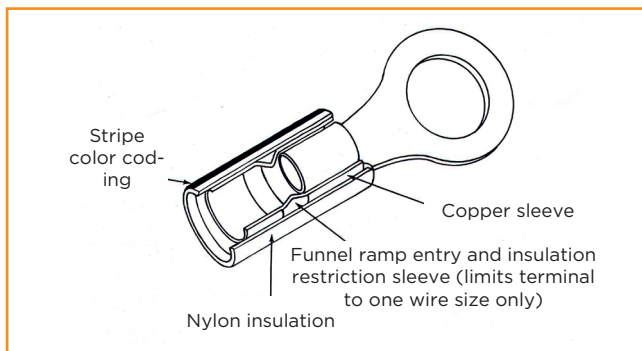

Standard Splices

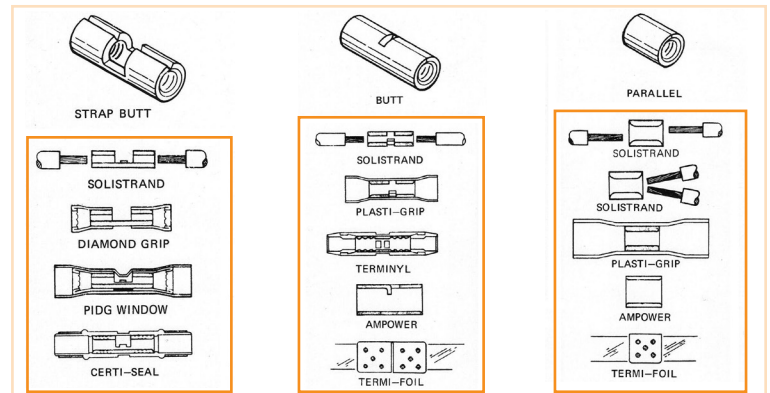

COPALUM Terminal and Splice Uninsulated Terminals for Aluminum Wire

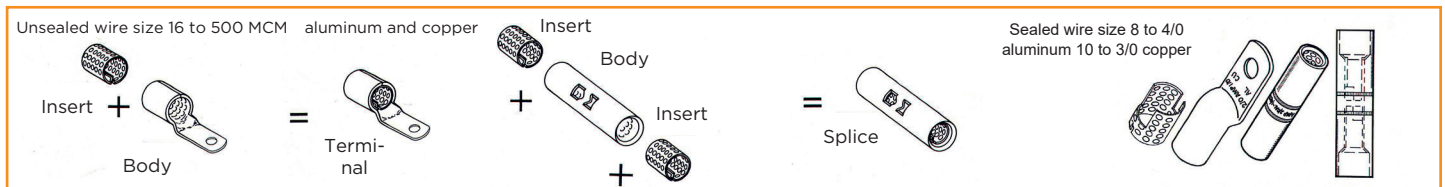

Closed-End Splices



Tooling Solutions for Aerospace, Defense and Marine

3.4 Terminal Styles

FASTON RECEPTACLE

OFFSET RING TONGUE

RING
Captivated to stud; nut must be removed from stud for installation.

Multi-stud
One terminal fits various stud sizes

RECTANGULAR
Captivated to stud; will not rotate when used with a barrier block; nut must be removed from stud for installation

KNIFE DISCONNECT
Allows a disconnectable splice

SLOTTED RING
Easy to install; nut does not have to be removed; can, however, vibrate loose

FLAG RING
Permits versatility in wire dressing in confined areas

FLANGED SPADE
Spade with stud captivation

HOOK RING
Variation of slotted ring, providing some captivation

SPADE
Easy to install; nut does not have to be removed; can, however, vibrate loose

SPRING SPADE
Spade with spring captivation to stud

Tooling Solutions for Aerospace, Defense and Marine

Glossary of Terms

ACTION PIN Contact (connector): Manufactured exclusively by TE Connectivity, having a split pin to provide gas tight retention in a printed circuit board plated-thru hole without solder.

Anvil (tooling): Most commonly used to identify that part of the crimping die — normally stationary — which positions and supports the terminal during crimping. Sometimes referred to as “nest”.

Arc Voltage: Voltage that continues to pass through a surge protector during activation of GDT (approx. 20 volts).

ASTM (American Society for Testing and Materials): A nonprofit industry-wide organization that formulates test methods and material specifications, and publishes standards, testing methods, recommended practices, definitions and other materials.

AWG (American Wire Gauge): The recognized method (in the United States) of specifying conductor size. The higher the gauge number, the smaller the conductor size.

Bare Conductor: A conductor not covered with insulating material.

Barrel: 1.) Connector Barrel: The section of the terminal, splice, or contact that accommodates the stripped conductor. **2.) Insulation Barrel:** The section of the terminal, splice, or contact that accommodates the conductor insulation. **3.) Open Barrel:** The section of a cap that accommodates the conductor.

Bellmouth: Flared at the mouth. The rear of a properly crimped wire barrel will have a slight flare (bellmouth) to relieve the strain on the wire strands as they leave the area of high compression and take their natural “lay”. A bellmouth may also be present in front of the wire barrel.

Breakdown Voltage: The voltage at which an insulator or dielectric fails to maintain the applied voltage.

Breakout: A region in a harness assembly where a wire or a group of wires is detached to form a separate, terminated branch. Also known as a transition.

Bunch Stranding: A method of twisting individual strands to form a finished stranded conductor. Specifically, a number of strands twisted together in a common direction and with a uniform pitch (or twist) per inch.

Butt Splice (electrical): A splice wherein two wires from opposite ends butt against each other, or against a stop, in the center of the splice.

Cable: Two or more wires in a twisted or parallel configuration. Also, a shielded wire.

Cabler: A machine that mechanically assembles a group of insulated wires.

Cabling: The act of twisting together two or more insulated components to form a cable.

Capacitance: The property of an electrical conductor (dielectric in a capacitor) that permits the storage of energy as a result of electrical displacement. The basic unit of capacitance is the farad, however, measurement is more commonly in microfarads or picofarads.

Carrier: A group of strands or ends used to form a finished braid.

Circular Mil Area (CMA): A unit of area equal to the area of a circle whose diameter is 1 mil (0.001 inch). Used chiefly in specifying cross-sectional areas of conductors.

Closed Entry Contact: Female contact designed to prevent entry of a pin or probing device having a cross-sectional dimension (diameter) greater than the mating pin.

Component: A wire or cable that is combined with other wires or cables to make a multi-component cable.

Concentric Stranding: A method of stranding conductor. Specifically, the final conductor is built up in layers so that the inner diameter of a succeeding layer is always equal to the outer diameter of the underlying layer.

Conductivity: The capability of a material to carry electrical current, usually expressed as a percentage of copper conductivity (copper being 100%). Specifically, the ratio of the current flow to the potential difference causing the flow. The reciprocal of resistance.

Conductor: The metallic strand or strands used to carry an electric current.

Conductor Resistance: The resistance to flow of the electrical current along a conductor. Expressed in ohms/1,000 feet (usually referenced to 20°C).

Conduit: A tubular raceway for holding wires or cables.

Connector: A device used to physically and electrically connect two or more conductors.

Contact: The element in a connector that makes the actual electrical connection. Also the parts of a connector that actually carry the electrical current, and are touched together or separated to control the flow.

Contact Crimp: A contact whose rear portion is a hollow cylinder that accepts the conductor. A crimping tool is applied to swage or form the contact metal firmly against the conductor. Sometimes referred to as a solderless contact.

Contact Engaging and Separating Force: Force required to either engage or separate contacts. Values are generally established for maximum and minimum forces.

Contact Resistance: Measurement of electrical resistance of mated contacts when assembled in a connector under typical service use. Electrical resistance is determined by measuring from the rear of the electrical area of one contact to the rear of the contact area of the mating contact (excluding both crimps) while carrying a specified test current.

Contact Size: The diameter of the engagement end of a pin contact; also related to the current carrying capacity of a contact.

Continuity: A continuous path for the flow of current in an electrical circuit.

Core: 1.) In cables, a component or assembly of components over which additional components, such as a shield or a sheath, are applied. 2.) Inner wall of dual-wall heat-shrinkable tubing.

Crimp: The final configuration of a terminal barrel after the necessary compression forces have been applied to cause a functional union between the terminal barrel and the wire.

Crimper (tooling): Often used to identify that part of the crimping die — usually the moving part — which indents or compresses the terminal barrel. Also called indenter.

Crimp Height: A top to bottom measurement of the crimped barrel, using a crimp height comparator in the prescribed manner.

Crimping Chamber: Area of a crimping tool in which a contact or terminal is crimped; the crimping enclosure formed by the mating of the anvil (nest) and crimper (indenter). When the dies or jaws are fully closed or bottomed, it is the crimping chamber that is checked with a go no-go plug gauge to confirm that the crimp produced by the tooling satisfies the crimp height specification.

Crimping Dies: A term used to identify the shaping tools that, when moved toward each other, produce a certain desirable shape to the barrel of the terminal or contact that has been placed between them. Crimping dies are often referred to as die sets or as die inserts.

Crimping Head: Tooling containing jaws and linkage for use in pneumatic or hydraulic powered units to crimp loose-piece contacts/terminals that may be too large for hand tool applications.

Crimping Tool: A term commonly used to identify a hand held mechanical device that is used to crimp a contact, terminal or splice.

Cross Crimp: A crimp that deforms the terminal by exerting on the top and bottom of the terminal barrel without confining the sides. Usually identified by a raised crescent (moon) shaped form on the surface of the crimp.

Current: A movement or flow of electrons. Also, the measure of this flow, expressed in amperes.

Current-carrying Capacity: The maximum current an insulated conductor is capable of carrying without exceeding its insulation- and/or jacket temperature limitations under specified ambient conditions.

Current Rating: The maximum continuous electrical flow of current recommended for a given situation. It is expressed in amperes.

Die: See crimping dies.

Die Closure: Term used to designate a crimping area (crimping chamber) when the dies are fully closed or bottomed. Die closure is checked with go/no go plug gauge to confirm that the crimp produced by the tooling satisfies the crimp height specification.

Dielectric: A material that serves as an insulator. The amount of resistance to voltage in a given insulation.

Dielectric Isolation (IC): Most silicon integrated circuits depend on back biased semiconductor junctions to provide isolation between components on the chip. Dielectric isolation involves a number of additional process steps, which result in silicon dioxide rather than a junction surrounding each component to be isolated. The silicon dioxide, a dielectric, provides the necessary isolation.

Dielectric Strength: Maximum voltage a dielectric can withstand without rupture. Expressed as volts per mil.

Discontinuity: Rated interconnection: broken connection (open circuit) or loss of a specified connection characteristic. Transient phenomena: Short-term interruption or unacceptable variation in current or voltage.

Drain Wire: In a cable, an un-insulated conductor laid over the component, or components, in a foil-shield cable. Used as a ground connection.

Electromagnetic Compatibility (EMC): The ability of an electronic device to operate in its intended environment without its performance being affected by EMI and without generating EMI that will affect other tooling.

Tooling Solutions for Aerospace, Defense and Marine

Glossary of Terms

Electromagnetic Interference (EMI): Unwanted electrical or electromagnetic energy that causes undesirable responses, degrading performance or complete malfunctions in electronic tooling.

Electromotive Force (emf): See voltage.

EMI: Abbreviation for electro magnetic interference.

Extraction Tool: A tool used for removing contacts from a connector body.

F Crimp: A crimp that brings the center of the barrel along an open seam downward into a V.

Ferrule: A short tube used to make solderless connections to shielded or coaxial cable. Also molded into the plastic inserts of multiple contact connectors to provide strong, wear-resistant shoulders on which contact retaining springs can bear.

FFC: Flexible flat cable; flat flexible cable; or flexible flat conductor. A form of multiple conductor cable consisting of parallel flat metal strips imbedded in a flat flexible insulating material.

Flat Braid: A braided shield composed of flatstrands.

Flat Cable: A cable with each component in a single, flat plane.

Flat Conductor: A conductor having a rectangular cross section, as opposed to a round or square cross section.

Fretting Corrosion: A form of accelerated oxidation that appears at the interface of contacting materials undergoing slight cyclic relative motion. All non-nobel metals (tin) are susceptible to some degree of fretting corrosion and will suffer contact resistance increases.

Gauge: A term used to denote the physical size of a wire. See also AWG.

Ground: A connection, intentional or accidental, between an electrical circuit and the earth or some conducting body (e.g. chassis) serving in place of earth.

Grounding Conductor: A conductor that provides a current return path from an electrical device to ground.

Hardness: A general term that correlates with strength, rigidity, and resistance to abrasion or penetration. Measured on Shore or Rockwell scales.

Harness: A system providing electrical connection between two or more points.

Hertz (Hz): International standard term for cycles per second. Named after the German physicist Heinrich R. Hertz (e.g., 60 cycles per second is equal to 60 hertz or 60 Hz).

Inductance: One cause of reactance. An electromagnetic phenomenon in which the expanding and collapsing of a magnetic field surrounding a conductor or device tends to impede changes in current. The effects of inductance become greater as frequencies increase. The basic unit for inductance is the henry.

Insertion Tool: A tool used to insert removable contacts into a connector.

Insulation Barrel: See barrel.

Insulation Crimp: The area of a terminal splice or contact that has been formed around the insulation of a wire.

Insulation Displacement: A terminating technique whereby an insulated wire is forced into a restrictive slot in a terminal, during which time the wire insulation is displaced, and the bare wire engages the sides of the slot.

Insulation Grip: The ability of certain crimped terminals to hold firmly in place both the conductor and a small portion of insulation. This prevents the conductor from being exposed due to insulation receding away from the terminal.

Insulation Resistance: The electrical resistance between two conductors separated by an insulating material.

Interference: Electrical or electromagnetic disturbance causing undesirable response in electronic tooling.

Jack: A connecting device into which a plug can be inserted to make circuit connections. The jack may also have contacts which open or close to perform switching functions when the plug is inserted or removed. See also: receptacle.

Jacket: 1.) A material covering over a wire or cable assembly. 2.) Outer covering of a dual-wall heat-shrinkable tubing.

Jack screw: A screw attached to one half of a two-piece, multiple-contact connector and used to draw both halves together and to separate them.

kV (kilovolt): A unit equal to 1,000 volts.

Mega (M): A prefix meaning one million (10⁶).

Multiconductor: More than one component within a single-cable complex.

Nominal: A descriptor applied to a dimension representing the center of the range of tolerance or a value if no tolerance is applied.

“O” Crimp: An insulation support crimp for open barrel terminals and contacts. In its crimped form it resembles an “O” and conforms to the shape of the round wire insulation. “O” crimp is also used to describe the circumferential crimps used on COAXICON ferrules.

Open Barrel: See barrel.

Peripheral Seal: A seal provided around the periphery of connector inserts to prevent the ingress of fluids or contaminants at the perimeter of mated connectors.

Pigtail: A short conductor or wire extending from an electrical or electronic device to serve as a jumper or ground connection.

Pin Contact: An electrical terminal, usually in a connector. Normally a smaller termination than a lug.

Pretinned: Description of an electrical component to which solder has been applied prior to soldering.

Primary Insulation: The inner member of a dual wall wire insulation. The insulation applied directly on the conductor.

Printed Circuit Board (PCB): An insulating board serving as a base for a printed circuit. When the printing process is completed, the board may include printed components, as well as printed wiring.

Rated Voltage: The maximum voltage at which an electric component can operate for extended periods without undue degradation.

Receptacle: Usually the fixed or stationary half of a two-piece multiple contact connector. Also the connector half usually mounted on a panel and containing socket contacts.

Removable Contact: A contact that can be mechanically joined to or removed from an insert. Usually special tools are required to lock the contact in place or remove it for repair or replacement.

Resistance: A measure of the difficulty in moving electrical current through a conductor or insulation when a voltage is applied. It is measured in ohms.

Resonance: A frequency at which captive reactance and inductive reactance

Ribbon Cable: Flat cable with conductors that have been individually insulated together. Its structure is usually characterized by individual

colors of insulation for each conductor, although a single color may be used for all conductors.

Serrations: The small grooves or indentations within a terminal wire barrel. The serrations increase the tensile strength and improve the electrical conductivity of the crimped termination.

Sleeve: The insulated or metallic covering over the barrel of a terminal.

Solid Conductor: A conductor composed of one single strand.

Splice: A joint connecting conductors with good mechanical strength and conductivity; a terminal that permanently joins two or more wires.

Strand: A single unit of a conductor.

Strip: To remove insulation from a wire or cable.

Surface Resistance: The ratio of the direct current applied to an insulation system to the current that passes across the surface of the system.

Surface Resistance: The ratio of the direct current applied to an insulation system to the current that passes across the surface of the system.

Tab: Used to scribe the flat blade portion of certain terminals (e.g. FASTON tab, taper tab, solder tab).

Tab-lok Crimp: A type of crimp used on FASTON flag terminals whereby a tab on the wire barrel is inserted through a slot in the terminal. The crimping action flattens the tab between two lances, which in turn are locked over the tab.

Terminal: An electrically conductive item designed to be attached to a circuit or device for convenience in making electrical connections.

Terminal Area: The portion of a printed circuit - usually along the edge - used for making the input-output connections. Sometimes this term is used synonymously with pad.

Terminal Barrel: See barrel.

Trimming: The adjustment of resistor or capacitor values in thick or thin film circuits by pattern changes, irreversible thermally induced changes, or removal of portions of material by laser or abrasive techniques. Dynamic trim is unique to these technologies, and of great value to circuit design and manufacture.

Volt (V): The unit of measurement for electromotive force (emf). It is equivalent to the force required to produce 1 ampere through a resistance of 1 ohm.

Voltage (E): The term most often used to designate electrical pressure that exists between two points and is capable of producing a flow of current when a closed circuit is connected between the two points. Voltage is measured in volts, millivolts, microvolts and kilovolts. The terms electromotive force (emf), potential, potential difference and voltage drop are often referred to as voltage.

Voltage Drop: The voltage developed across a component or conductor by the flow of current through the resistance or impedance of that component or conductor.

Voltage Rating: The voltage that may be continuously applied to wire.

W Crimp: A confined type of crimp that makes two longitudinal indentations which form a “W” cross section. Used on SOLISTRAND terminals.

Wall Thickness: The thickness of the applied insulation or jacket.

Wire: A single conductor covered with insulation.

Wire Barrel: See barrel.

Wire Crimp: See crimp.



Let's Connect

Learn more about our comprehensive line of tooling solutions at tooling.te.com. To find the right TE tooling for your needs, call us at **717-810-2082** or email toolingSales@te.com.

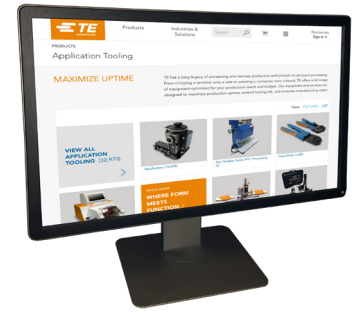

TE Connectivity Technical Support Center

USA:	1.800.522.6752	UK:	+44.0800.267666
Canada:	1.800.522.6752	France:	+33.1.34.20.8686
Mexico:	+52.55.11.06.0800	Netherlands:	+31.73.624.6999
Latin/S. America	+54.11.4733.2200	China:	+86.400.820.6015
Germany:	+49.6151.607.1999		

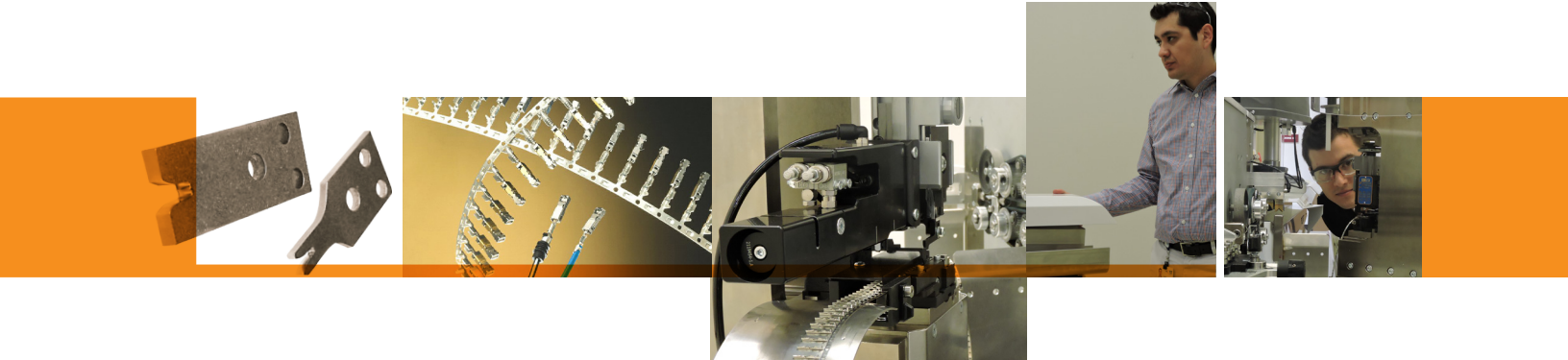

Waste Not. Want Not.

Whether it's time or scrap, in manufacturing everyone knows that waste costs money. With our on-site certification and consultation services, we can help you:

- Reduce downtime
- Reduce scrap
- Maintain crimp quality
- Improve manufacturing efficiency



Time is Money.

In manufacturing downtime can be expensive. That's why TE is constantly working to improve product availability and delivery rates. With a strong global footprint, short lead times and a strong distribution channel, TE has the

equipment and the accessories to keep production online.

To check distributor stock and availability for your tooling needs go to: www.te.com/commerce/sck/cdi.do

te.com

CERTI-CRIMP, TE Connectivity, TE connectivity (logo) and Every Connection Counts are trademarks. All other logos, products and/or company names referred to herein might be trademarks of their respective owners.

The information given herein, including drawings, illustrations and schematics which are intended for illustration purposes only, is believed to be reliable. However, TE Connectivity makes no warranties as to its accuracy or completeness and disclaims any liability in connection with its use. TE Connectivity's obligations shall only be as set forth in TE Connectivity's Standard Terms and Conditions of Sale for this product and in no case will TE Connectivity be liable for any incidental, indirect or consequential damages arising out of the sale, resale, use or misuse of the product. Users of TE Connectivity products should make their own evaluation to determine the suitability of each such product for the specific application.

© 2018 TE Connectivity Ltd. family of companies All Rights Reserved.

2-1773444-1 10/18 Original

Contact us today to learn more

E-mail (Americas): fieldservicesnorthamerica@te.com

Phone (Americas): 800-722-1111 or 717-986-3434

E-mail (EMEA): TEFE1@te.com

Phone (EMEA): +49-6151-607-1518

For additional information download catalog no. 1-1307619-0 from tooling.te.com.

www.te.com

