



Glenair®

SERIES 96

HIGH-PERFORMANCE WIRE AND CABLE

FAST TURNAROUND, NO MINIMUMS, MIL-SPEC AND COMMERCIAL

JUNE 2013



SERIES 96

No Dollar
or Quantity
Minimum Orders
**NO
MINS.**

HIGH-PERFORMANCE WIRE AND CABLE FOR INTERCONNECT APPLICATIONS

*The right solution for every mission-critical
interconnect harness/assembly*



Glenair is unique in the interconnect industry in that we design and manufacture every key component part used in today's most high-performance interconnect harnesses and assemblies. From discrete contacts to connectors, backshells, EMI/RFI shielding, jacketing—and now wire and cable—Glenair manufactures and supplies the full range of requirements.

Introducing Glenair high performance wire and cable: Our line of high-performance wire and cable includes Mil-Spec and commercial variants of commonly specified M22759 type multi-conductor shielded cabling, as well as a full range of Quadrax, Coaxial, fiber optic, and protocol-specific (Ethernet, USB, Firewire and eSATA) cables. We also offer several unique and high-performance cable solutions of our own design for harsh-environment power and signal applications. Best of all, Glenair high-performance wire and cable is offered in short runs with no length or dollar minimums. Fast turnaround—up to and including stock—is our model. Call the factory or visit our website for price and delivery information.

Glenair[®]

Glenair, Inc.
1211 Air Way
Glendale, CA
91201-2497
818-247-6000
sales@glenair.com
www.glenair.com

**Series 96 High Performance Cable
for Interconnect Applications
Table of Contents**



NO
No Dollar
or Quantity
Minimum Orders
MINS.

Introduction and General Reference

Overview of Glenair cable and jacketing materials for every high-performance application requirement

A

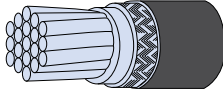

M22759 Single-Ended Data Transmission Wire

Glenair's range of AS22759 wire and cable is qualified to SAE requirements

B

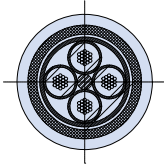

Quadrax Cable

High-speed transmission solutions for 10/100/1000BASE-T Ethernet applications

C



Coaxial Cable

50 and 75 ohm Coaxial cable for use in radio frequency and microwave applications

D



TurboFlex™ Power Transmission Wire

TurboFlex™ power distribution cables are fabricated from highly flexible conductors and high-performance insulation to produce cables ideally suited for applications where flexibility, durability, and weight reduction are required

E



Optical Fiber

Singlemode and multimode graded index fiber optic cable for mission-critical applications

F

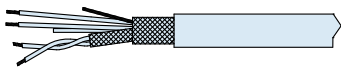

Protocol-Specific/High Speed Cable

For USB, Ethernet, SATA and other general-purpose/protocol-specific applications

G



Index

Part number index

Index



Series 96 High Performance Cable for Interconnect Applications

A

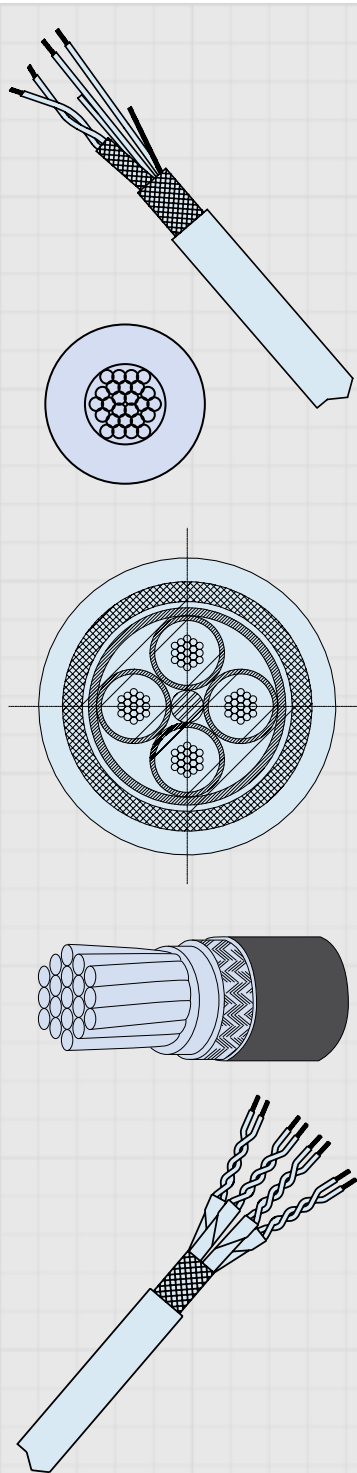

**Engineered wire and
cable solutions**

Sophisticated wire and cable solutions— from optical fiber to high-flexibility power transmission cable

**NO
MINS.**
No Dollar
or Quantity
Minimum Orders

In addition to terminated and tested cable assemblies and cordsets, Glenair is pleased to offer our customers discrete bulk cable for on-site termination. All of the cables in this catalog have been designed and manufactured for optimal performance in mission-critical applications such as soldier systems, medical equipment, aerospace, geophysical and other military and commercial environments that rely on guaranteed signal integrity and cable durability. The catalog is organized according to application type, beginning with general-purpose non-impedance-controlled signal wire, and continuing with a full range of high-performance shielded multi-conductor cables, including Coaxial, Quadradx, flexible power, fiber optic, and so on. Glenair cables are designed to optimize flexibility, weight reduction, ruggedness, and insulator quality. Our protocol-specific cables are offered with guidance as to shielding properties, impedance performance, attenuation, temperature rating, bend radius, weight, and maximum practical distance.

Custom Capabilities

TurboFlex	Highly flexible interconnect conductors and cables for power distribution applications
Duraelectric	High-performance, flexible jacket material with outstanding resistance to environmental stress factors including heat, UV radiation and caustic chemicals
Multiconductor cables	Custom, short-run cables for unique applications such as robotics, defense electronics, and soldier systems
Overbraiding	Extensive range of conductive and non-conductive wire and fabric braid materials, including ultra-lightweight composites and micro-filaments

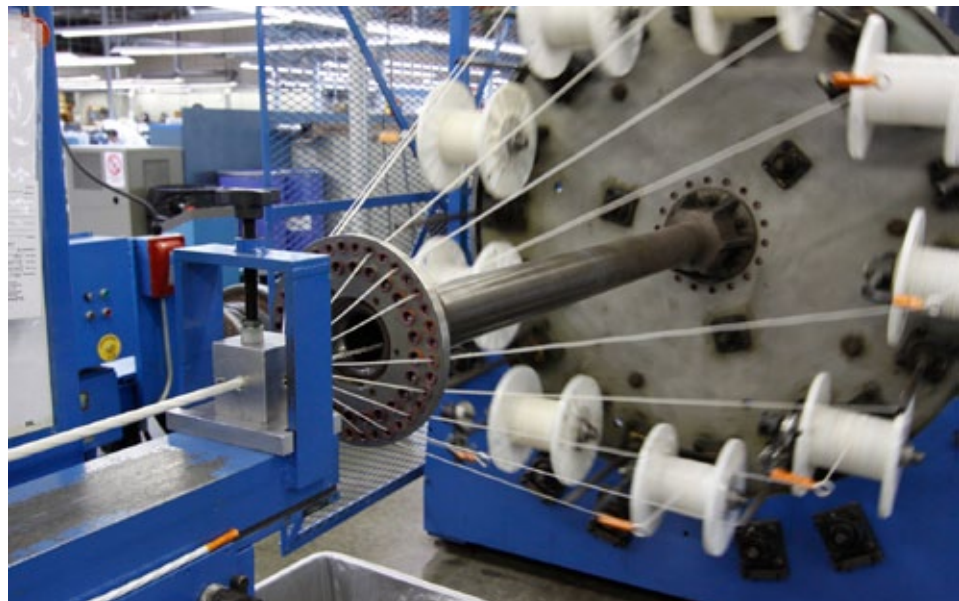

Glenair's vertically integrated connector, hardware and cable facilities are perfectly positioned to supply catalog and custom short cable runs for the broad range of interconnect applications from non-impedance controlled transmission wire to high-speed, protocol-specific cabling—all with no dollar or length minimums.

Series 96 High Performance Cable for Interconnect Applications



Rugged environmental jacketing in a broad range of material types and colors

- Extruded, blown-on and heat shrink jacketing for harsh application environments
- General purpose polyurethane
- Low-smoke, zero halogen Duraelectric™
- Chemically-resistant Viton®
- Industry standard neoprene
- Selected materials CBRN tested

High-performance cable and jacketing materials for every application requirement: Immersion, chemical or caustic fluid exposure, temperature extremes, and UV radiation.



Glenair operates one of the largest multi-spindle overbraiding operations in the world



Coiled cable configurations for radio and comms applications are a Glenair specialty

Wire Type	Application	Commonly Used With
M22759 Single-Ended Data Transmission Wire	Non-impedance controlled signal applications	Non-shielded 39029 contacts
Quadrax Cable	10/100/1000BASE-T Ethernet applications	854-001/854-002 Quadrax contacts
Coaxial Cable	50 Ohm/75 Ohm RF transmission	Size #16, #12, #8 Coaxial pin and socket contacts
TurboFlex	High-performance (temperature, weight, flexibility) power transmission	Series 970 PowerTrip™, MIL-DTL-38999, Series 80 Mighty Mouse,
Optical Fiber	Ruggedized mil-aero singlemode and multimode optical data transmission	EyeBeam (expanded beam) Glenair High Density (GHD) Series 80 Mighty Mouse fiber optic (Size #23, #20HD and #16) MIL-DTL-38999 Size #16 and #20 MIL-T-29504 QPL
Protocol Specific Cables	Commercial digital data device connections including Ethernet, USB, SATA/eSATA, Spacewire, LVDS/CML	High Speed Mighty Mouse Mighty Mouse with Ultra-Twinax Differential Twinax contacts SuperSeal USB/RJ45

All Glenair cable part numbers are in stock and ready for immediate, same-day shipment with no length or dollar minimums.

SAE AS22759
TYPE

MIL-SPEC DATA TRANSMISSION WIRE

No Dollar
or Quantity
Minimum orders
**NO
MINS.**

*Airframe non-impedance-matched
data transmission cable*



Glenair's range of AS22759 wire and cable is manufactured and qualified to SAE requirements for this, the most commonly applied of all aerospace data transmission media. We offer a complete selection of styles, sizes and colors in twist, overbraid, and jacketed configurations. Wire may be supplied etched, stripped and cut to specific lengths to meet any application requirement. Airframe non-impedance matched data transmission cable is often only available in long cable runs and/or minimum dollar or length quantities. Glenair offers same-day shipment on popular wire—and every 39029 contact you might need—all with no minimums.

AS39029 Contacts for Series 80 Mighty Mouse, MIL-DTL-38999, MIL-DTL-28840, et al

			
Crimp	PC Tail	Solder Cup	Thermocouple

Glenair®

Glenair, Inc.
1211 Air Way
Glendale, CA
91201-2497
818-247-6000
sales@glenair.com
www.glenair.com

M22759 Single-Ended Data Transmission Wire Selection Guide



Mil-Spec

B

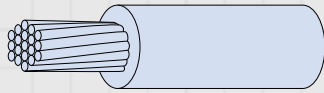

M22759/11 Silver Coated Copper Wire with Extruded PTFE Insulation

For high temperature applications such as aircraft engines and where increased abrasion resistance is required

B-6



M22759/16 Tin Coated Copper Wire with Extruded ETFE Insulation

For high temperature applications such as aircraft engines and where increased abrasion resistance and solderability is required

B-8



M22759/18 Tin Coated Copper Wire with Thin-Wall Extruded ETFE Insulation

For aerospace applications where light weight, abrasion resistance, mechanical durability and solderability are required

B-10

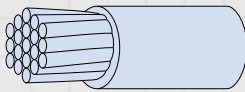

M22759/32 Tin Coated Copper Wire with Crosslinked, Modified ETFE Insulation

For high temperature, light weight aerospace applications where mechanical strength, abrasion resistance and solderability are required

B-12

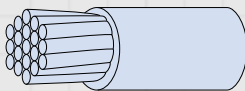

M22759/33 Silver Coated Copper Wire with Crosslinked, Modified ETFE Insulation

For high temperature, light weight aerospace applications where increased mechanical strength and abrasion resistance is required

B-14

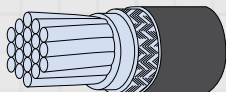

M22759/34 Tin Coated Copper Wire with Overall Braid and Extruded ETFE Insulation

For high temperature airframe and avionics applications where abrasion resistance, mechanical durability, and EMI/RFI shielding are required

B-16

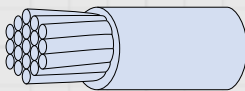

M22759/44 Silver Coated Copper Wire with Crosslinked, Extruded ETFE Insulation

For protected harness applications where high temperature resistance, mechanical durability and flexibility are required

B-18

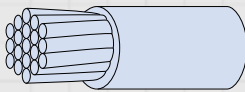

M22759/45 Nickel Coated Copper Wire with Crosslinked, Extruded ETFE Insulation

For protected harness applications where high temperature resistance, mechanical durability, corrosion resistance and flexibility are required

B-20

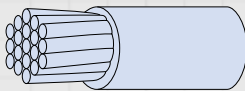

M22759/46 Nickel Coated High Strength Copper Wire with Crosslinked, Extruded ETFE Insulation

For high temperature applications where mechanical durability and, corrosion resistance are primary requirements

B-22

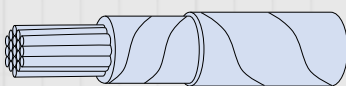

M22759/90 Nickel Coated High Strength Copper Wire with Double Layer Tape Wrap Insulation

For high temperature applications where mechanical durability, corrosion resistance and cable strength are primary requirements

B-24



SAE-AS39029 Crimp Contact Selection Guide

B

Military Part Number	Glenair Part Number	Contact Size	Wire Accommodation	Pin / Socket	BIN Color Striping		
M39029/56-348	850-001-22-348	22	22-28 AWG	Socket	Orange	Yellow	Grey
M39029/56-351	850-001-20-351	20	20-24 AWG	Socket	Orange	Green	Brown
M39029/56-352	850-001-16-352	16	16-20 AWG	Socket	Orange	Green	Red
M39029/56-353	850-001-12-353	12	12-14 AWG	Socket	Orange	Green	Orange
M39029/56-527	850-001-10-527	10	10 AWG	Socket	Green	Red	Violet
M39029/57-354	850-003-22-354	22	22-28 AWG	Socket	Orange	Green	Yellow
M39029/57-357	850-003-20-357	20	20-24 AWG	Socket	Orange	Green	Violet
M39029/57-358	850-003-16-358	16	16-20 AWG	Socket	Orange	Green	Grey
M39029/57-359	850-003-12-359	12	12-14 AWG	Socket	Orange	Green	White
M39029/58-360	850-002-22-360	22	22-28 AWG	Pin	Orange	Blue	Black
M39029/58-363	850-002-20-363	20	20-24 AWG	Pin	Orange	Blue	Orange
M39029/58-364	850-002-16-364	16	16-20 AWG	Pin	Orange	Blue	Yellow
M39029/58-365	850-002-12-365	12	12-14 AWG	Pin	Orange	Blue	Green
M39029/58-528	850-002-10-528	10	10 AWG	Pin	Green	Red	Grey
M39029/63-368	850-021-20-368	20	20-24 AWG	Socket	Orange	Blue	Grey
M39029/64-369	850-022-20-369	20	20-24 AWG	Pin	Orange	Blue	White

BIN Color Coding

0 BLACK	1 BROWN	2 RED	3 ORANGE	4 YELLOW	5 GREEN	6 BLUE	7 VIOLET	8 GREY	9 WHITE
------------	------------	----------	-------------	-------------	------------	-----------	-------------	-----------	------------

SAE-AS39029 Crimp Contact Selection Guide



Mil-Spec

B

Military Part Number	Glenair Part Number	Contact Size	Wire Accommodation	Pin / Socket	BIN Color Striping		
M39029/83-450	850-004-20-450	20	22-26 AWG	Pin	Yellow	Green	Black
M39029/83-451	850-004-20-451	20	28-32 AWG	Pin	Yellow	Green	Brown
M39029/83-508	850-004-20-508	20	20-24 AWG	Pin	Green	Black	Grey
M39029/84-452	850-005-20-452	20	22-26 AWG	Socket	Yellow	Green	Red
M39029/84-453	850-005-20-453	20	28-32 AWG	Socket	Yellow	Green	Orange
M39029/84-509	850-005-20-509	20	20-24 AWG	Socket	Green	Black	White
M39029/106-614	850-006-22-614	22	22-28 AWG	Socket	Blue	Brown	Yellow
M39029/106-615	850-006-20-615	20	20-24 AWG	Socket	Blue	Brown	Green
M39029/106-616	850-006-16-616	16	16-20 AWG	Socket	Blue	Brown	Blue
M39029/106-617	850-006-12-617	12	12-14 AWG	Socket	Blue	Brown	Violet
M39029/106-618	850-006-10-618	10	10 AWG	Socket	Blue	Brown	Grey
M39029/107-620	850-007-22-620	22	22-28 AWG	Pin	Blue	Red	Black
M39029/107-621	850-007-20-621	20	20-24 AWG	Pin	Blue	Black	Brown
M39029/107-622	850-007-16-622	16	16-20 AWG	Pin	Blue	Red	Red
M39029/107-623	850-007-12-623	12	12-14 AWG	Pin	Blue	Red	Orange
M39029/107-624	850-007-10-624	10	10 AWG	Pin	Blue	Red	Yellow

BIN Color Coding									
0 BLACK	1 BROWN	2 RED	3 ORANGE	4 YELLOW	5 GREEN	6 BLUE	7 VIOLET	8 GREY	9 WHITE



Series 80 Mighty Mouse Contact Arrangements

B

Series 80 Mighty Mouse Contact Arrangements

Contact Size		Contact Quantity					Contact Arrangement					
		#23	#20	#20HD	#16	#12	Series 800	Series 801	Series 802	Series 803	Series 804	Series 805
Size #23 Contacts 5 Amp Max. Current 500 VAC #22-#28 AWG		3					5-3	5-3	5-3	5-3	5-3	Not Avail.
		4					6-4	6-4	6-4	6-4	6-4	8-4
		6					6-6	6-6	6-6	6-6	6-6	8-6
		7					6-7	6-7	6-7	6-7	6-7	8-7
		10					7-10	7-10	7-10	7-10	7-10	9-10
		13					8-13	8-13	8-13	8-13	8-13	10-13
		19					9-19	9-19	9-19	9-19	9-19	11-19
		26					10-26	10-26	10-26	10-26	10-26	12-26
		37					12-37	13-37	12-37	12-37	12-37	15-37
		55					Not Avail.	16-55	14-55	14-55	14-55	18-55
		85					Not Avail.	17-85	15-85	Not Avail.	Not Avail.	19-85
130					Not Avail.	21-130	21-130	Not Avail.	Not Avail.	23-130		
Size #20HD Contacts 7.5 Amp Max. Current 750 VAC #20-#24 AWG				3			6-23	6-23	6-23	6-23	6-23	8-23
				5			7-25	7-25	7-25	7-25	7-25	9-25
				8			8-28	8-28	8-28	8-28	8-28	10-28
				10			9-210	9-210	9-210	9-210	9-210	11-210
				20			12-220	13-220	12-220	12-220	12-220	15-220
				35			Not Avail.	16-235	14-235	14-235	14-235	18-235
				41			Not Avail.	17-241	15-241	Not Avail.	Not Avail.	19-241
		69			Not Avail.	21-269	21-269	Not Avail.	Not Avail.	23-269		
Size #16 Contacts 13 Amp Max. Current 1800 VAC #16-#20 AWG					1		6-1	6-1	6-1	6-1	6-1	8-1
					2		8-2	8-2	8-2	8-2	8-2	10-2
					4		9-4	9-4	9-4	9-4	9-4	11-4
					5		10-5	10-5	10-5	10-5	10-5	12-5
					7		12-7	13-7	12-7	12-7	12-7	15-7
Size #16 Coaxial Contacts 50-75 Ohms					12		Not Avail.	16-12	14-12	14-12	14-12	18-12
					14		Not Avail.	17-14	15-14	Not Avail.	Not Avail.	19-14
					22		Not Avail.	21-22	21-22	Not Avail.	Not Avail.	23-22
Size #12 Contacts 23 Amp Max. Current 1800 VAC #12-#14 AWG						1	7-1	7-1	7-1	7-1	7-1	9-1
						2	10-2	10-2	10-2	10-2	10-2	12-2
						2	12-2	13-2	12-2	12-2	12-2	15-2
						3	12-3	13-3	12-3	12-3	12-3	15-3
Contact Arrangements with Mixed Size (Combo) Layouts		4	2				8-200	8-200	8-200	8-200	8-200	10-200
		8	2				9-201	9-201	9-201	9-201	9-201	11-201
		4			2		9-200	9-200	9-200	9-200	9-200	11-200
		8			2		10-202	10-202	10-202	10-202	10-202	12-202
		4				2	10-201	10-201	10-201	10-201	10-201	12-201
		6				2	12-200	13-200	12-200	12-200	12-200	15-200
		10				2	12-201	13-201	12-201	12-201	12-201	15-201
		12				1	10-200	10-200	10-200	10-200	10-200	12-200
Series 800	Series 801	Series 802	Series 803	Series 804	Series 805							

MIL-DTL-38999 Series I, II, and III Contact Arrangements



Mil-Spec

B

Shell Size and Insert Arrangements			Number of Pins			
MS Series I	MS Series II	D38999 Series III	22D	20	16	12
9-35	8-35	A35	6			
9-98	8-98	A98		3		
11-2	10-2	B2			2	
11-4	10-4	B4		4		
11-5	10-5	B5		5		
11-35	10-35	B35	13			
11-98	10-98	B98		6		
11-99	10-99	B99		7		
13-4	12-4	C4			4	
13-8	12-8	C8		8		
13-35	12-35	C35	22			
13-98	12-98	C98		10		
15-5	14-5	D5			5	
15-15	14-15	D15		14	1	
15-18	14-18	D18		18		
15-19	14-19	D19		19		
15-35	14-35	D35	37			
15-97	14-97	D97		8	4	
17-6	16-6	E6				6
17-8	16-8	E8			8	
17-26	16-26	E26		26		
17-35	16-35	E35	55			
17-99	16-99	E99		21	2	
19-11	18-11	F11			11	
19-28	18-28	F28		26	2	
19-30	18-30	F30		29	1	
19-32	18-32	F32		32		
19-35	18-35	F35	66			
19-45	18-45	F45	67			
21-11	20-11	G11				11
21-16	20-16	G16			16	
21-24	20-24	G24		24		
21-25	20-25	G25		25		
21-27	20-27	G27		27		
21-35	20-35	G35	79			
21-39	20-39	G39		37	2	
21-41	20-41	G41		41		
23-21	22-21	H21			21	
23-32	22-32	H32		32		
23-34	22-34	H34		34		
23-35	22-35	H35	100			
23-36	22-36	H36		36		
23-53	22-53	H53		53		
23-55	22-55	H55		55		
23-97	22-97	H97			16	
23-99	22-99	H99			11	

Shell Size and Insert Arrangements			Number of Pins			
MS Series I	MS Series II	D38999 Series III	22D	20	16	12
25-4	24-4	J4		48	8	
25-19	24-19	J19				19
25-24	24-24	J24			12	12
25-29	24-29	J29			29	
25-35	24-35	J35	128			
25-37	N/A	J37	37		37	16
25-43	24-43	J43		23	20	
25-61	24-61	J61		61		



Selection of MIL-DTL-38999 type subminiature connectors with insert arrangements utilizing standard AS39029 crimp contacts and suited for use with single-ended data transmission wire

GENERAL PURPOSE, HIGH-TEMPERATURE RANGE

How To Order

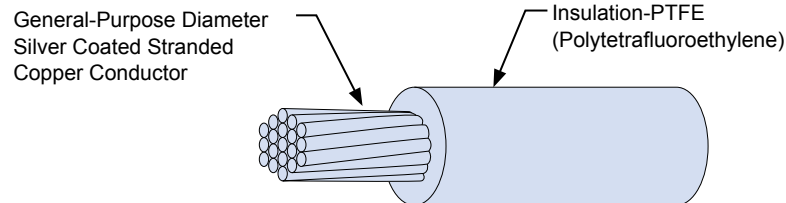
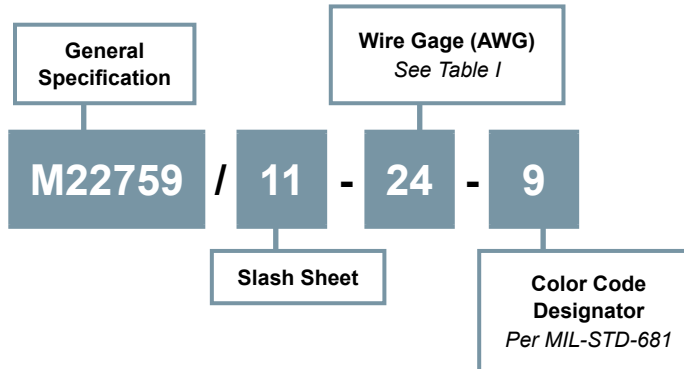

Table I

Part Number	Wire Size (AWG)	Stranding (Number of strands x AWG gage of strands)	Diameter of stranded conductor (inches)		Finished Wire		
			min	max	Resistance at 20° C (68° F) (Ohms/1000 ft) max	Diameter (inches)	Weight (lbs/1000 ft) max
M22759/11-28-*	28	7 x 36	.014	.015	63.8	.033 ± .002	1.36
M22759/11-26-*	26	19 x 38	.018	.020	38.4	.038 ± .002	1.90
M22759/11-24-*	24	19 x 36	.023	.025	24.3	.043 ± .002	2.58
M22759/11-22-*	22	19 x 34	.029	.032	15.1	.049 ± .002	3.72
M22759/11-20-*	20	19 x 32	.037	.040	9.19	.058 ± .002	5.43
M22759/11-18-*	18	19 x 30	.046	.050	5.79	.068 ± .002	8.14
M22759/11-16-*	16	19 x 29	.052	.057	4.52	.075 ± .002	10.0
M22759/11-14-*	14	19 x 27	.065	.072	2.88	.090 ± .002	15.1
M22759/11-12-*	12	19 x 25	.082	.090	1.81	.111 ± .003	24.1
M22759/11-10-*	10	37 x 26	.106	.112	1.19	.139 ± .004	37.8
M22759/11-8-*	8	133 x 29	.158	.169	.658	.202 ± .004	65.5

M22759/11
Silver Coated Copper Wire
with Extruded TFE Insulation



Table II: Test Data	
Temperature Rating	200° C (392° F) max conductor temperature
Voltage Rating	600 volts (rms) at sea level
Spark Test of Primary Insulation	not required
Impulse Dielectric Test	100% test, 8.0 kilovolts (peak) for sizes 18 and smaller 6.5 kilovolts (peak) for sizes 16 and larger.
Insulation Resistance	50,000 megohms for 1000 ft (min)
Wrap Test	"wrap back" test required, no cracking. Oven temperature: 313 ± 2° C (500 ± 3.6° F)
Blocking	260 ± 2° C (500 ± 3.6° F)
Shrinkage	0.03 inch max at 290 ± 2° C (554 ± 3.6° F)
Wicking	no requirement
Low Temperature (Cold Bend)	bend temperature: -65° ± 2° C (-85 ± 3.6° F) dielectric test: 3,000 volts (rms), 60 Hz
Thermal Shock	oven temperature: 200 ± 2° C (392 ± 3.6° F) max change in measurement: 0.06 inch
Flammability	post-flame dielectric test not required
Life Cycle	oven temperature 275 ± 2° C (527 ± 3.6° F) dielectric test: 3,000 volts (rms), 60 Hz
Dielectric Test After Immersion	3,000 volts (rms), 60 Hz
Acid Resistance	dielectric test, 3,000 volts (rms), 60 Hz
Conductor Strand Adhesion Requirements	shall be in accordance with 3.6.11 of MIL-W-22759
Abrasion Resistance After Immersion	no requirement
Humidity Resistance	no requirement
Surface Resistance	500 megohm-inches (min) initial and final readings
Smoke	290° C (554° F)
Color	in accordance with MIL-STD-104, class 1; white preferred
Color Striping or Banding Durability	250 cycles (500 strokes) minimum, 500 grams weight
Identification Durability	125 cycles (250 strokes) minimum, 500 grams weight
Wire Length Requirements	schedule A

Notes

Cable identified with manufacturer's name and part number.
Cable is sold in 1 foot increments. Specify desired length on purchase order.

SMALL DIAMETER EXCELLENT SOLDERABILITY

How To Order

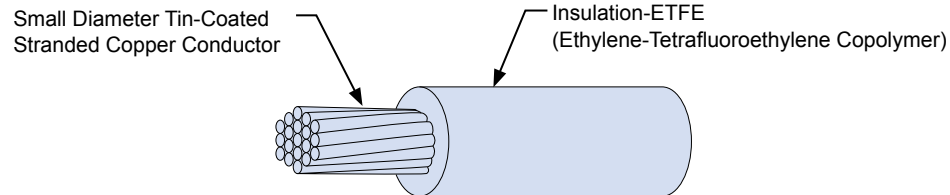
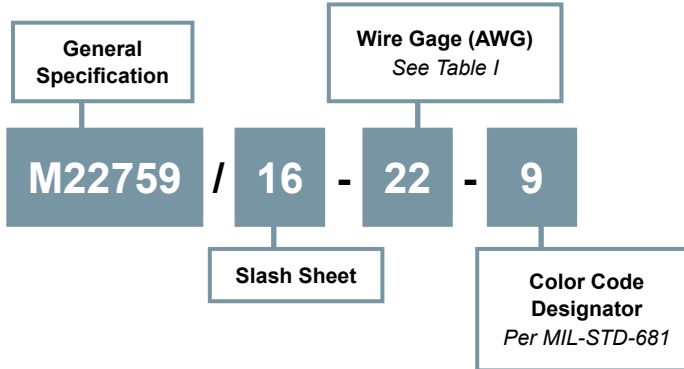

Part Number	Wire Size (AWG)	Stranding (Number of strands x AWG gage of strands)	Diameter of stranded conductor (inches)		Finished Wire		
			min	max	Resistance at 20° C (68° F) (Ohms/1000 ft) max	Diameter (inches)	Weight (lbs/1000 ft) max
			M22759/16-24-*	24			
M22759/16-22-*	22	19 x 34	.029	.031	16.2	.052 ± .002	3.68
M22759/16-20-*	20	19 x 32	.037	.039	9.88	.060 ± .002	5.36
M22759/16-18-*	18	19 x 30	.046	.049	6.23	.071 ± .002	7.89
M22759/16-16-*	16	19 x 29	.052	.055	4.81	.079 ± .002	9.95
M22759/16-14-*	14	19 x 27	.065	.069	3.06	.093 ± .002	14.9
M22759/16-12-*	12	19 x 25	.084	.089	2.02	.114 ± .003	22.6
M22759/16-10-*	10	37 x 26	.106	.112	1.26	.139 ± .003	35.1
M22759/16-8-*	8	133 x 29	.158	.169	.701	.199 ± .003	63.5
M22759/16-6-*	6	133 x 27	.198	.212	.445	.250 ± .003	99.9
M22759/16-4-*	4	133 x 25	.250	.268	.280	.312 ± .004	157
M22759/16-2-*	2	665 x 30	.320	.340	.183	.388 ± .004	245
M22759/16-1-*	1	817 x 30	.360	.380	.149	.431 ± .005	314
M22759/16-0-*	0	1045 x 30	.395	.425	.116	.479 ± .006	391
M22759/16-00-*	00	1330 x 30	.440	.475	.091	.546 ± .007	504

M22759/16
Tin Coated Copper Wire
with Extruded (ETFE) Insulation



Table II: Test Data	
Temperature Rating	150° C (302° F) max conductor temperature
Voltage Rating	600 volts (rms) at sea level
Short Term Thermal Stability	7 hours at 230 ± 2° C (446 ± 3.6° F). Quality conformance test, group II; test procedures and requirements as in life cycle test except for time and temperature of oven exposure.
Spark Test of Primary Insulation	not required
Impulse Dielectric Test	100% test, 8.0 kilovolts (peak)
Insulation Resistance, Initial	24 AWG through 14 AWG: 5,000 megohms for 1000 ft (min) 12 AWG through 6: 3,000 megohms for 1000 ft (min) 4 AWG through 00: 2,000 megohms for 1000 ft (min)
Wrap Test	"wrap back" test required, no cracking. Oven temperature: 200 ± 2° C (392 ± 3.6° F)
Blocking	200 ± 2° C (392 ± 3.6° F)
Shrinkage	0.125 inch max at 200 ± 2° C (392 ± 3.6° F)
Wicking	no requirement
Low Temperature (Cold Bend)	bend temperature: -65° ± 2° C (-85 ± 3.6° F) dielectric test: 2,200 volts (rms), 60 Hz
Thermal Shock	oven temperature: 150 ± 2° C (302 ± 3.6° F) max change in measurement: 24 AWG through 12 AWG: 0.060 inch 10 AWG through 8 AWG: 0.100 inch 6 AWG through 00 AWG: 0.125 inch
Flammability	vertical flame test; 2 seconds (max) after-flame, 5.50 in (max) burn length. Post-flame dielectric test not required.
Life Cycle	oven temperature 200 ± 2° C (392 ± 3.6° F) dielectric test: 2,200 volts (rms), 60 Hz
Dielectric Test After Immersion	2,200 volts (rms), 60 Hz
Acid Resistance	no requirement
Conductor Strand Adhesion Requirements	shall be in accordance with 3.6.11 of MIL-W-22759
Abrasion Resistance After Immersion	no requirement
Humidity Resistance	after humidity exposure, wire shall meet the requirements for initial insulation resistance.
Surface Resistance	24 AWG through 12 AWG: 500 megohm-inches (min) initial and final readings 10 AWG through 00 AWG: no requirement
Smoke	200° C (392° F)
Color	in accordance with MIL-STD-104, class 1; white preferred
Color Striping or Banding Durability	125 cycles (250 strokes) minimum, 500 grams weight
Identification of Product	Required
Identification Durability	125 cycles (250 strokes) minimum, 500 grams weight
Wire Length Requirements	schedule A

Notes

Cable identified with manufacturer's name and part number.
 Cable is sold in 1 foot increments. Specify desired length on purchase order.



M22759/18 Tin Coated Copper Wire with Thin-Wall Extruded ETFE Insulation

SMALL DIAMETER, LIGHTWEIGHT INSULATION EXCELLENT SOLDERABILITY

How To Order

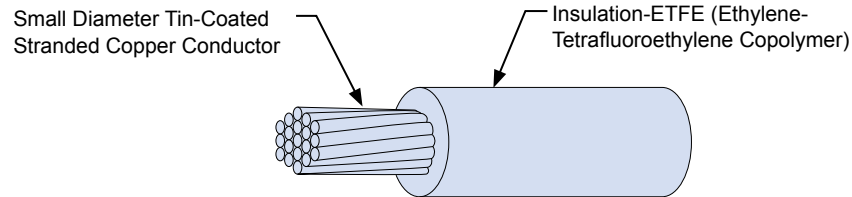
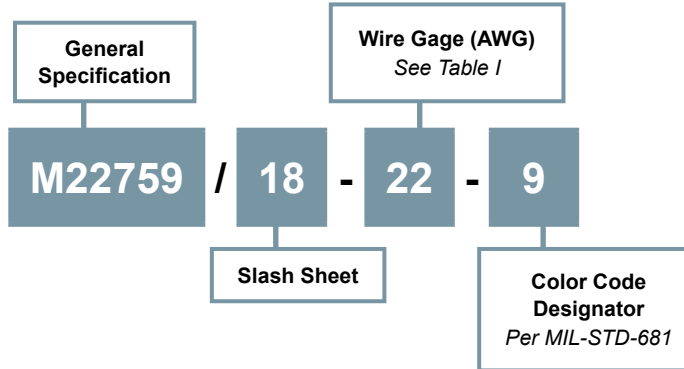

Part Number	Wire Size (AWG)	Stranding (Number of strands x AWG gage of strands)	Diameter of stranded conductor (inches)		Finished Wire		
			min	max	Resistance at 20° C (68° F) (Ohms/1000 ft) max	Diameter (inches)	Weight (lbs/1000 ft) max
			M22759/18-26-*	26			
M22759/18-24-*	24	19 x 36	.023	.024	26.2	.036 ± .002	2.12
M22759/18-22-*	22	19 x 34	.029	.031	16.2	.043 ± .002	3.16
M22759/18-20-*	20	19 x 32	.037	.039	9.88	.051 ± .002	4.76
M22759/18-18-*	18	19 x 30	.046	.049	6.23	.061 ± .002	7.10
M22759/18-16-*	16	19 x 29	.052	.055	4.81	.070 ± .002	9.14
M22759/18-14-*	14	19 x 27	.065	.069	3.06	.085 ± .002	14.1
M22759/18-12-*	12	19 x 25	.084	.089	2.02	.107 ± .003	21.8
M22759/18-10-*	10	37 x 26	.106	.112	1.26	.134 ± .003	34.1

M22759/18
Tin Coated Copper Wire
with Thin-Wall Extruded ETFE Insulation



Mil-Spec

B

Table II: Test Data	
Temperature Rating	150° C (302° F) max conductor temperature
Voltage Rating	600 volts (rms) at sea level
Short Term Thermal Stability	7 hours at 230 ± 2° C (446 ± 3.6° F). Quality conformance test, group II; test procedures and requirements as in life cycle test except for time and temperature of oven exposure.
Spark Test of Primary Insulation	not required
Impulse Dielectric Test	100% test, 8.0 kilovolts (peak)
Insulation Resistance, Initial	26 AWG through 20 AWG: 5,000 megohms for 1000 ft (min) 18 AWG through 14: 3,000 megohms for 1000 ft (min) 12 AWG through 10: 2,000 megohms for 1000 ft (min)
Wrap Test	"wrap back" test required, no cracking. Oven temperature: 200 ± 2° C (392 ± 3.6° F)
Blocking	200 ± 2° C (392 ± 3.6° F)
Shrinkage	0.125 inch max at 200 ± 2° C (392 ± 3.6° F)
Wicking	no requirement
Low Temperature (Cold Bend)	bend temperature: -65° ± 2° C (-85 ± 3.6° F) dielectric test: 2,200 volts (rms), 60 Hz
Thermal Shock	oven temperature: 150 ± 2° C (302 ± 3.6° F) max change in measurement: 26 AWG through 12 AWG: 0.060 inch 10 AWG: 0.100 inch
Flammability	vertical flame test; 2 seconds (max) after-flame, 5.50 in (max) burn length. Post-flame dielectric test not required.
Life Cycle	oven temperature 200 ± 2° C (392 ± 3.6° F) dielectric test: 2,200 volts (rms), 60 Hz
Dielectric Test After Immersion	2,200 volts (rms), 60 Hz
Acid Resistance	no requirement
Conductor Strand Adhesion Requirements	shall be in accordance with 3.6.11 of MIL-W-22759
Abrasion Resistance After Immersion	no requirement
Humidity Resistance	after humidity exposure, wire shall meet the requirements for initial insulation resistance.
Surface Resistance	26 AWG through 12 AWG: 500 megohm-inches (min) initial and final readings 10 AWG: no requirement
Smoke	200° C (392° F)
Color	in accordance with MIL-STD-104, class 1; white preferred
Color Striping or Banding Durability	125 cycles (250 strokes) minimum, 500 grams weight
Identification of Product	Required. Shall be ink printing only.
Identification Durability	125 cycles (250 strokes) minimum, 500 grams weight
Wire Length Requirements	schedule A

Notes

Cable identified with manufacturer's name and part number.
 Cable is sold in 1 foot increments. Specify desired length on purchase order.



M22759/32 Tin Coated Copper Wire with Crosslinked, Modified ETFE Insulation

SMALL DIAMETER, EXCELLENT SOLDERABILITY; HIGH-TEMPERATURE, HIGH-FLEX INSULATION

How To Order

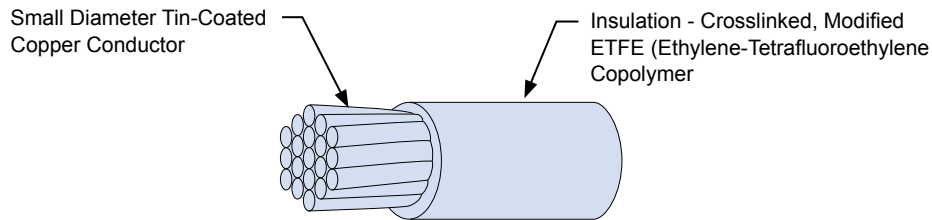
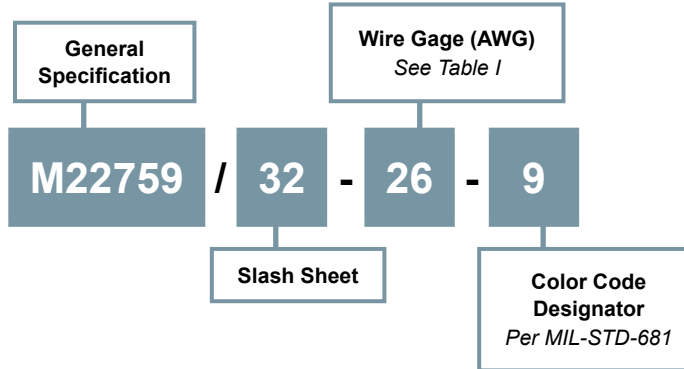

Table I

Part Number	Wire Size (AWG)	Stranding (Number of strands x AWG gage of strands)	Diameter of stranded conductor (inches)		Finished Wire		
			min	max	Resistance at 20° C (68° F) (Ohms/1000 ft) max	Diameter (inches)	Weight (lbs/1000 ft) max
M22759/32-30-*	30	7 x 38	.011	.013	108.4	.024 ± .002	.66
M22759/32-28-*	28	7 x 36	.014	.016	68.6	.027 ± .002	.91
M22759/32-26-*	26	19 x 38	.018	.020	41.3	.032 ± .002	1.4
M22759/32-24-*	24	19 x 36	.023	.025	26.2	.037 ± .002	2.0
M22759/32-22-*	22	19 x 34	.029	.031	16.2	.043 ± .002	2.8
M22759/32-20-*	20	19 x 32	.037	.039	9.88	.050 ± .002	4.3
M22759/32-18-*	18	19 x 30	.046	.049	6.23	.060 ± .002	6.5
M22759/32-16-*	16	19 x 29	.052	.055	4.81	.068 ± .002	8.3
M22759/32-14-*	14	19 x 27	.065	.069	3.06	.085 ± .002	13.0
M22759/32-12-*	12	37 x 28	.084	.089	2.02	.103 ± .003	19.7

M22759/32
Tin Coated Copper Wire
with Crosslinked, Modified ETFE Insulation



Table II: Test Data	
Temperature Rating	150° C (302° F) max conductor temperature
Voltage Rating	600 volts (rms) at sea level
Short Term Thermal Stability	7 hours at 230 ± 2° C (446 ± 3.6° F). Quality conformance test, group II; test procedures and requirements as in life cycle test except for time and temperature of oven exposure.
Spark Test of Primary Insulation	not required
Impulse Dielectric Test	100% test, 8.0 kilovolts (peak)
Insulation Thickness	.005 inch (minimum)
Insulation Resistance, Initial	5,000 megohms for 1000 ft (min)
Physical Properties of Insulation	pulled at 2 inches per minute. tensile strength, 5,000 lbf/in ² (min.) elongation, 75% (min.)
Propellant Resistance	no dielectric breakdown.
Crosslinking Proof Test	7 hours at 300° C ± 3° C (572 ± 5.4° F). Quality conformance test, group II. Requirements and procedures as for life cycle except for time and temperature.
Wrap Test	"wrap back" test required, no cracking. Oven temperature: 200 ± 2° C (392 ± 3.6° F)
Blocking	200 ± 2° C (392 ± 3.6° F)
Shrinkage	0.125 inch max at 200 ± 2° C (392 ± 3.6° F)
Wicking	no requirement
Solderability	all conductors shall be tested in accordance with MIL-STD-202, method 208 without steam aging.
Low Temperature (Cold Bend)	bend temperature: -65° ± 2° C (-85 ± 3.6° F) dielectric test: 2,500 volts (rms), 60 Hz
Thermal Shock	oven temperature: 150 ± 2° C (302 ± 3.6° F) max change in measurement .060 inch
Flammability	quality conformance test, group II.
Life Cycle	500 hours at 200° C ± 3° C (392 ± 5.4° F). Dielectric test, 2,500 volts (rms), 60 Hz. Procedure to use mandrels coated with PTFE in the form of either enamel or wrapped tape, such that the diameter of the mandrels, after coating, still conform to the requirements of performance details.
Dielectric Test After Immersion	2,500 volts (rms), 60 Hz
Acid Resistance	no requirement
Conductor Strand Adhesion Requirements	shall be in accordance with 3.6.11 of MIL-W-22759
Abrasion Resistance After Immersion	no requirement
Humidity Resistance	after humidity exposure, wire shall meet the requirements for initial insulation resistance.
Surface Resistance	500 megohms - inches (min), initial and final readings
Smoke	200° C (392° F)
Color	in accordance with MIL-STD-104, class 1; white preferred. Conformity of color to the limits of MIL-STD-104 shall not be required after crosslinking proof test or life cycle oven exposure.
Color Striping or Banding Durability	125 cycles (250 strokes) minimum, 500 grams weight
Identification of Product	not required for size 24 and smaller. color code designator not required.
Identification Durability	125 cycles (250 strokes) minimum, 500 grams weight
Wire Length Requirements	schedule B

Notes

Cable identified with manufacturer's name and part number.
 Cable is sold in 1 foot increments. Specify desired length on purchase order.

SMALL DIAMETER, HIGH-FLEX INSULATION

How To Order

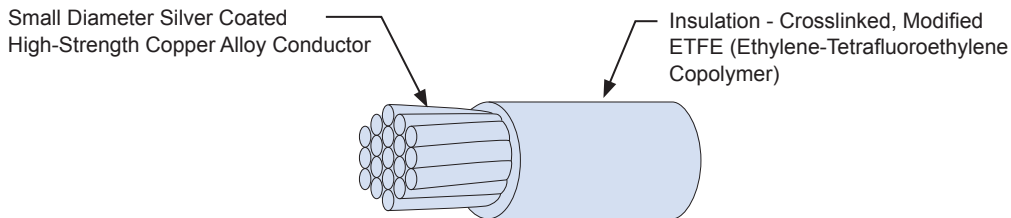
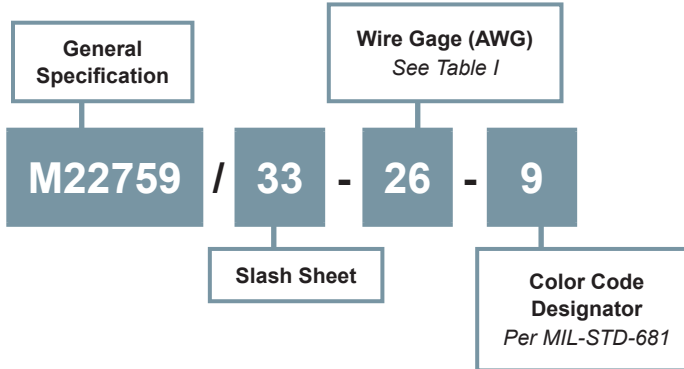

Part Number	Wire Size (AWG)	Stranding (Number of strands x AWG gage of strands)	Diameter of stranded conductor (inches)		Finished Wire		
			min	max	Resistance at 20° C (68° F) (Ohms/1000 ft) max	Diameter (inches)	Weight (lbs/1000 ft) max
M22759/33-30-*	30	7 x 38	.011	.012	117.4	.024 ± .002	.66
M22759/33-28-*	28	7 x 36	.014	.016	74.4	.027 ± .002	.91
M22759/33-26-*	26	19 x 38	.018	.020	44.8	.032 ± .002	1.4
M22759/33-24-*	24	19 x 36	.023	.025	28.4	.037 ± .002	2.0
M22759/33-22-*	22	19 x 34	.029	.031	17.5	.043 ± .002	2.9
M22759/33-20-*	20	19 x 32	.037	.039	10.7	.050 ± .002	4.4

M22759/33
Silver Coated Copper Wire
with Crosslinked, Modified ETFE Insulation



Table II: Test Data	
Temperature Rating	200° C (392° F) max conductor temperature
Voltage Rating	600 volts (rms) at sea level
Short Term Thermal Stability	7 hours at 230 ± 2° C (446 ± 3.6° F). Quality conformance test, group II; test procedures and requirements as in life cycle test except for time and temperature of oven exposure.
Spark Test of Primary Insulation	not required
Impulse Dielectric Test	100% test, 8.0 kilovolts (peak)
Insulation Thickness	.005 inch (minimum)
Insulation Resistance, Initial	5,000 megohms for 1000 ft (min)
Physical Properties of Insulation	pulled at 2 inches per minute. tensile strength, 5,000 lbf/in ² (min.) elongation, 75% (min.)
Propellant Resistance	no dielectric breakdown.
Crosslinking Proof Test	7 hours at 300° C ± 3° C (572 ± 5.4° F). Quality conformance test, group II. Requirements and procedures as for life cycle except for time and temperature.
Wrap Test	"wrap back" test required, no cracking. Oven temperature: 313 ± 3° C (595 ± 5.4° F)
Blocking	230 ± 3° C (446 ± 5.4° F)
Shrinkage	0.125 inch max at 200 ± 2° C (392 ± 3.6° F)
Wicking	no requirement
Solderability	all conductors shall be tested in accordance with MIL-STD-202, method 208 without steam aging.
Low Temperature (Cold Bend)	bend temperature: -65° ± 2° C (-85 ± 3.6° F) dielectric test: 2,500 volts (rms), 60 Hz
Thermal Shock	oven temperature: 200 ± 3° C (392 ± 5.4° F) max change in measurement .060 inch
Flammability	quality conformance test, group II.
Life Cycle	500 hours at 230° C ± 3° C (446 ± 5.4° F). Dielectric test, 2,500 volts (rms), 60 Hz. Procedure to use mandrels coated with PTFE in the form of either enamel or wrapped tape, such that the diameter of the mandrels, after coating, still conform to the requirements of performance details.
Dielectric Test After Immersion	2,500 volts (rms), 60 Hz
Acid Resistance	no requirement
Conductor Strand Adhesion Requirements	shall be in accordance with 3.6.11 of MIL-W-22759
Abrasion Resistance After Immersion	no requirement
Humidity Resistance	after humidity exposure, wire shall meet the requirements for initial insulation resistance.
Surface Resistance	500 megohms - inches (min), initial and final readings
Smoke	250° C ± 5° C (482° ± 9° F); no visible smoke.
Color	in accordance with MIL-STD-104, class 1; white preferred. Conformity of color to the limits of MIL-STD-104 shall not be required after crosslinking proof test or life cycle oven exposure.
Color Striping or Banding Durability	125 cycles (250 strokes) minimum, 500 grams weight
Identification of Product	not required for size 24 and smaller. color code designator not required.
Identification Durability	125 cycles (250 strokes) minimum, 500 grams weight
Wire Length Requirements	schedule B

Notes

Cable identified with manufacturer's name and part number.
 Cable is sold in 1 foot increments. Specify desired length on purchase order.

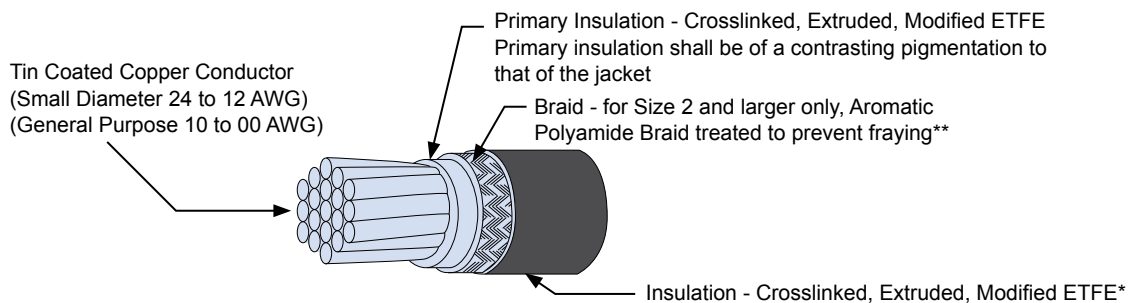
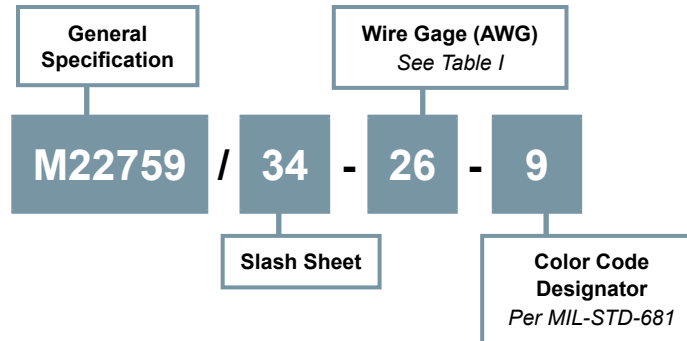
GENERAL-PURPOSE OR SMALL DIAMETER, EXCELLENT SOLDERABILITY; EMI/RFI SHIELDED
How To Order

*ETFE - Ethylene-Tetrafluoroethylene Copolymer

**Braid (sizes 2 and larger): Bright aromatic polyamide yarn, 200 denier, 100 filaments, tightly formed, uniform in appearance, treated with a clear finisher coating. The finisher coating shall be compatible with the temperature rating and performance requirements of the insulated wire.

Part Number	Wire Size (AWG)	Stranding (Number of strands x AWG gage of strands)	Diameter of stranded conductor (inches)		Finished Wire		
			min	max	Resistance at 20° C (68° F) (Ohms/1000 ft) max	Diameter (inches)	Weight (lbs/1000 ft) max
M22759/34-24-*	24	19 x 36	.023	.025	26.2	.045 ± .002	2.3
M22759/34-22-*	22	19 x 34	.029	.031	16.2	.050 ± .002	3.2
M22759/34-20-*	20	19 x 32	.037	.039	9.88	.058 ± .002	4.7
M22759/34-18-*	18	19 x 30	.046	.049	6.23	.070 ± .003	7.2
M22759/34-16-*	16	19 x 29	.052	.055	4.81	.077 ± .003	9.0
M22759/34-14-*	14	19 x 27	.065	.069	3.06	.094 ± .003	13.8
M22759/34-12-*	12	37 x 28	.084	.089	2.02	.111 ± .003	20.5
M22759/34-10-*	10	37 x 26	.106	.113	1.26	.134 ± .004	32.4
M22759/34-8-*	8	133 x 29	.158	.173	.701	.195 ± .008	60.3
M22759/34-6-*	6	133 x 27	.198	.217	.445	.241 ± .010	94
M22759/34-4-*	4	133 x 25	.250	.274	.280	.310 ± .010	150
M22759/34-2-*	2	665 x 30	.320	.340	.183	.405 ± .016	239
M22759/34-1-*	1	817 x 30	.360	.380	.149	.445 ± .016	290
M22759/34-0-*	0	1045 x 30	.395	.425	.116	.485 ± .016	377
M22759/34-00-*	00	1330 x 30	.440	.475	.091	.545 ± .016	487

M22759/34
Tin Coated Copper Wire
with Overall Braid and Extruded ETFE Insulation



Table II: Test Data	
Temperature Rating	150° C (302° F) max conductor temperature
Voltage Rating	600 volts (rms) at sea level
Short Term Thermal Stability	7 hours at 230 ± 2° C (446 ± 3.6° F). Quality conformance test, group II; test procedures and requirements as in life cycle test except for time and temperature of oven exposure.
Spark Test of Primary Insulation	1,500 volts (rms), 60 Hz
Impulse Dielectric Test	100% test, 8.0 kilovolts (peak)
Insulation Thickness	0.003 inch (min) for primary insulation 0.004 inch (min) for outer jacket 0.008 inch (min) for total insulation
Insulation Resistance, Initial	sizes 24 through 10: 5,000 megohms for 1000 ft (min) sizes 8 through 00: 3,000 megohms for 1,000 ft (min)
Physical Properties of Insulation	pulled at 2 inches per minute. tensile strength, 5,000 lb/in ² (min.) 24-10 AWG: elongation, 125% (min.) 8-00 AWG: elongation, 75% (min.)
Propellant Resistance	no dielectric breakdown.
Crosslinking Proof Test	7 hours at 300° C ± 3° C (572 ± 5.4° F). Quality conformance test, group II. Requirements and procedures as for life cycle except for time and temperature.
Wrap Test	"wrap back" test required, no cracking. Oven temperature: 200 ± 3° C (392 ± 5.4° F) sizes and larger, mandrel diameter shall be 3 times the OD of the wire.
Blocking	200 ± 3° C (392 ± 5.4° F)
Shrinkage	0.125 inch max at 200 ± 2° C (392 ± 3.6° F)
Wicking	procedure II; weight increase, no requirement. Dye travel between layers of insulation 2.25 in (max) from end of specimen.
Solderability	all conductors shall be tested in accordance with MIL-STD-202, method 208 without steam aging.
Low Temperature (Cold Bend)	bend temperature: -65° ± 2° C (-85 ± 3.6° F) dielectric test: 2,500 volts (rms), 60 Hz
Thermal Shock Resistance	oven temperature: 150 ± 3° C (302 ± 5.4° F) max change in measurement: 24 AWG through 12 AWG: 0.060 in 10 AWG through 8 AWG: 0.100 in 6 AWG through 00 AWG: 0.125 in
Flammability	quality conformance test, group II.
Life Cycle	500 hours at 200° C ± 3° C (392 ± 5.4° F). Dielectric test, 2,500 volts (rms), 60 Hz. Procedure to use mandrels coated with PTFE in the form of either enamel or wrapped tape, such that the diameter of the mandrels, after coating, still conform to the requirements of performance details.
Dielectric Test After Immersion	2,500 volts (rms), 60 Hz
Acid Resistance	no requirement
Conductor Strand Adhesion Requirements	shall be in accordance with 3.6.11 of MIL-W-22759
Abrasion Resistance After Immersion	no requirement
Humidity Resistance	after humidity exposure, wire shall meet the requirements for initial insulation resistance.
Surface Resistance	500 megohms - inches (min), initial and final readings
Smoke	200° C ± 2° C (392° ± 3.6° F); no visible smoke.
Color	in accordance with MIL-STD-104, class 1; white preferred. For braided constructions, color shall be dark green within Munsell color limits of 5Y 3/2 and 5B 2/0.5. Conformity of color to the limits of MIL-STD-104 shall not be required after crosslinking proof test or life cycle oven exposure.
Color Striping or Banding Durability	125 cycles (250 strokes) minimum, 500 grams weight
Identification of Product	not required for size 24 and smaller. color code designator not required.
Identification Durability	125 cycles (250 strokes) minimum, 500 grams weight
Wire Length Requirements	schedule B

SMALL DIAMETER, HIGH-TEMPERATURE, HIGH-FLEX INSULATION

How To Order

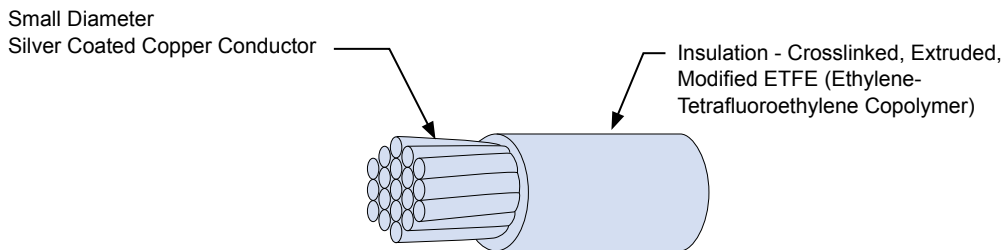
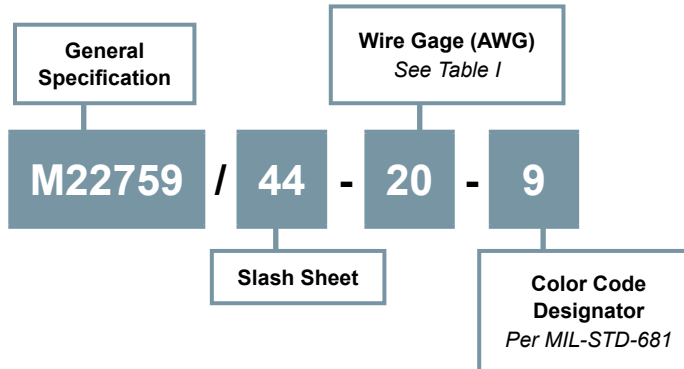

Table I

Part Number	Wire Size (AWG)	Stranding (Number of strands x AWG gage of strands)	Diameter of stranded conductor (inches)		Finished Wire		
			min	max	Resistance at 20° C (68° F) (Ohms/1000 ft) max	Diameter (inches)	Weight (lbs/1000 ft) max
M22759/44-28-*	28	7 x 36	.014	.015	63.8	.027 ± .002	.91
M22759/44-26-*	26	19 x 38	.018	.019	38.4	.032 ± .002	1.4
M22759/44-24-*	24	19 x 36	.023	.025	24.3	.037 ± .002	2.0
M22759/44-22-*	22	19 x 34	.029	.030	15.1	.043 ± .002	2.8
M22759/44-20-*	20	19 x 32	.037	.039	9.19	.050 ± .002	4.3
M22759/44-18-*	18	19 x 30	.046	.048	5.79	.060 ± .002	6.5
M22759/44-16-*	16	19 x 29	.052	.054	4.52	.068 ± .002	8.3
M22759/44-14-*	14	19 x 27	.065	.068	2.88	.086 ± .003	13.0
M22759/44-12-*	12	37 x 28	.084	.087	1.90	.103 ± .003	19.7

M22759/44
Silver Coated Copper Wire
with Crosslinked, Extruded ETFE Insulation



Table II: Test Data	
Temperature Rating	200° C (392° F) maximum continuous conductor temperature
Voltage Rating	600 volts (rms) at sea level
Short Term Thermal Stability	7 hours at 230 ± 2° C (446 ± 3.6° F). Quality conformance test, group II; test procedures and requirements as in life cycle test except for time and temperature of oven exposure.
Spark Test of Primary Insulation	not applicable
Impulse Dielectric Test	100% test, 8.0 kilovolts (peak)
Insulation Thickness	0.005 inch (min)
Insulation Resistance, Initial	5,000 megohms for 1000 ft (min)
Physical Properties of Insulation	pulled at 2 inches per minute. tensile strength, 5,000 lbf/in ² (min.) elongation, 75% (min.)
Propellant Resistance	no dielectric breakdown.
Crosslinking Proof Test	7 hours at 300° C ± 3° C (572 ± 5.4° F). Quality conformance test, group II. Requirements and procedures as for life cycle except for time and temperature.
Wrap Test	"wrap back" test. Oven temperature: 313 ± 3° C (595 ± 5.4° F)
Blocking	230 ± 3° C (446 ± 5.4° F)
Shrinkage	0.125 inch max at 230 ± 3° C (446 ± 5.4° F)
Wicking	not applicable
Solderability	all conductors shall be tested in accordance with MIL-STD-202, method 208 without steam aging.
Low Temperature (Cold Bend)	bend temperature: -65° ± 3° C (-85 ± 5.4° F) dielectric test: 2,500 volts (rms), 60 Hz
Thermal Shock Resistance	oven temperature: 200 ± 3° C (392 ± 5.4° F) max change in measurement: 0.060 in
Flammability	quality conformance test, group II.
Life Cycle	500 hours at 230° C ± 3° C (446 ± 5.4° F). Dielectric test, 2,500 volts (rms), 60 Hz. Procedure to use mandrels coated with PTFE in the form of either enamel or wrapped tape, such that the diameter of the mandrels, after coating, still conform to the requirements of performance details.
Dielectric Test After Immersion	2,500 volts (rms), 60 Hz
Acid Resistance	no requirement
Conductor Strand Adhesion Requirements	shall be in accordance with 3.6.11 of MIL-W-22759
Abrasion Resistance After Immersion	no requirement
Humidity Resistance	after humidity exposure, wire shall meet the requirements for initial insulation resistance.
Surface Resistance	500 megohms - inches (min), initial and final readings
Smoke	250° C ± 5° C (482° ± 9° F); no visible smoke.
Color	in accordance with MIL-STD-104, class 1; white preferred. Conformity of color to the limits of MIL-STD-104 shall not be required after crosslinking proof test or life cycle oven exposure.
Color Striping or Banding Durability	125 cycles (250 strokes) minimum, 500 grams weight
Identification of Product	not required for size 24 and smaller. color code designator not required.
Identification Durability	125 cycles (250 strokes) minimum, 500 grams weight
Wire Length Requirements	schedule B

Notes

Cable identified with manufacturer's name and part number.
 Cable is sold in 1 foot increments. Specify desired length on purchase order.

SMALL DIAMETER HARSH ENVIRONMENT, HIGH-TEMPERATURE RESISTANCE; HIGH-FLEX INSULATION

How To Order

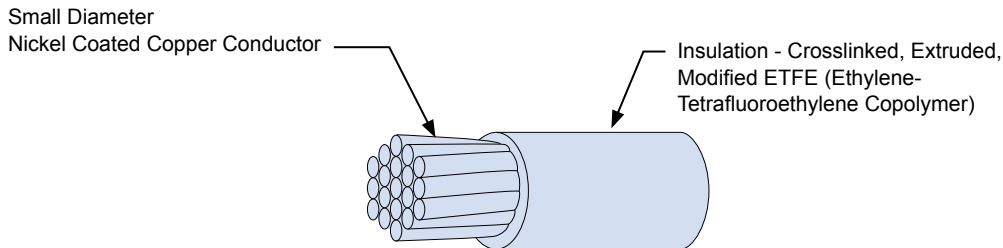
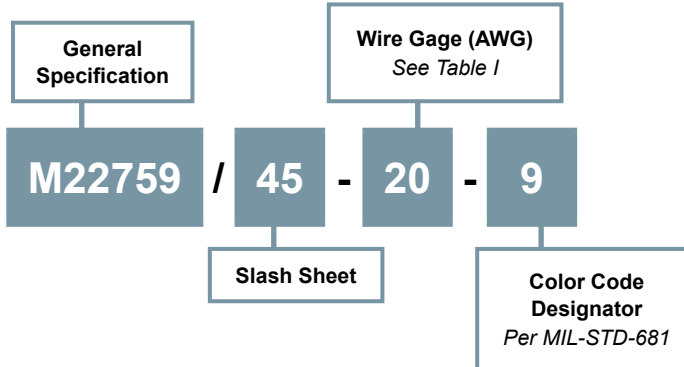

Part Number	Wire Size (AWG)	Stranding (Number of strands x AWG gage of strands)	Diameter of stranded conductor (inches)		Finished Wire		
			min	max	Resistance at 20° C (68° F) (Ohms/1000 ft) max	Diameter (inches)	Weight (lbs/1000 ft) max
M22759/45-28-*	28	7 x 36	.014	.016	67.9	.027 ± .002	.91
M22759/45-26-*	26	19 x 38	.018	.020	42.2	.032 ± .002	1.4
M22759/45-24-*	24	19 x 36	.023	.025	25.9	.037 ± .002	2.0
M22759/45-22-*	22	19 x 34	.029	.031	16.0	.043 ± .002	2.8
M22759/45-20-*	20	19 x 32	.037	.039	9.77	.050 ± .002	4.3
M22759/45-18-*	18	19 x 30	.046	.049	6.10	.060 ± .002	6.5
M22759/45-16-*	16	19 x 29	.052	.055	4.76	.068 ± .002	8.3
M22759/45-14-*	14	19 x 27	.065	.069	3.00	.085 ± .003	13.0
M22759/45-12-*	12	37 x 28	.084	.089	1.98	.103 ± .003	19.7

M22759/45
Nickel Coated Copper Wire
with Crosslinked, Extruded ETFE Insulation



Table II: Test Data	
Temperature Rating	200° C (392° F) maximum continuous conductor temperature
Voltage Rating	600 volts (rms) at sea level
Short Term Thermal Stability	7 hours at 230 ± 2° C (446 ± 3.6° F). Quality conformance test, group II; test procedures and requirements as in life cycle test except for time and temperature of oven exposure.
Spark Test of Primary Insulation	not applicable
Impulse Dielectric Test	100% test, 8.0 kilovolts (peak)
Insulation Thickness	0.005 inch (min)
Insulation Resistance, Initial	5,000 megohms for 1000 ft (min)
Physical Properties of Insulation	pulled at 2 inches per minute. tensile strength, 5,000 lbf/in2 (min.) elongation, 75% (min.)
Propellant Resistance	no dielectric breakdown.
Crosslinking Proof Test	7 hours at 300° C ± 3° C (572 ± 5.4° F). Quality conformance test, group II. Requirements and procedures as for life cycle except for time and temperature.
Wrap Test	"wrap back" test. Oven temperature: 313 ± 3° C (595 ± 5.4° F)
Blocking	230 ± 3° C (446 ± 5.4° F)
Shrinkage	0.125 inch max at 250 ± 5° C (482 ± 9° F)
Wicking	not applicable
Solderability	all conductors shall be tested in accordance with MIL-STD-202, method 208 without steam aging.
Low Temperature (Cold Bend)	bend temperature: -65° ± 3° C (-85 ± 5.4° F) dielectric test: 2,500 volts (rms), 60 Hz
Thermal Shock Resistance	oven temperature: 200 ± 3° C (392 ± 5.4° F) max change in measurement: 0.060 in
Flammability	quality conformance test, group II.
Life Cycle	500 hours at 230° C ± 3° C (446 ± 5.4° F). Dielectric test, 2,500 volts (rms), 60 Hz. Procedure to use mandrels coated with PTFE in the form of either enamel or wrapped tape, such that the diameter of the mandrels, after coating, still conform to the requirements of performance details.
Dielectric Test After Immersion	2,500 volts (rms), 60 Hz
Acid Resistance	no requirement
Conductor Strand Adhesion Requirements	shall be in accordance with 3.6.11 of MIL-W-22759
Abrasion Resistance After Immersion	no requirement
Humidity Resistance	after humidity exposure, wire shall meet the requirements for initial insulation resistance.
Surface Resistance	500 megohms - inches (min), initial and final readings
Smoke	250° C ± 5° C (482° ± 9° F); no visible smoke.
Color	in accordance with MIL-STD-104, class 1; white preferred. Conformity of color to the limits of MIL-STD-104 shall not be required after crosslinking proof test or life cycle oven exposure.
Color Striping or Banding Durability	125 cycles (250 strokes) minimum, 500 grams weight
Identification of Product	not required for size 24 and smaller. color code designator not required.
Identification Durability	125 cycles (250 strokes) minimum, 500 grams weight
Wire Length Requirements	schedule B

Notes

Cable identified with manufacturer's name and part number.
 Cable is sold in 1 foot increments. Specify desired length on purchase order.

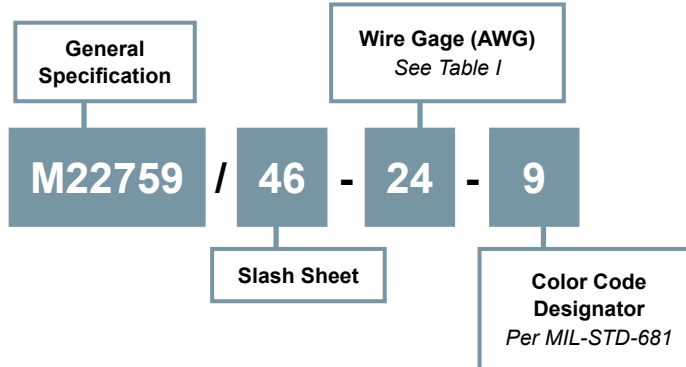
**SMALL DIAMETER HIGH-STRENGTH, HARSH ENVIRONMENT, HIGH-TEMPERATURE RESISTANCE;
HIGH-FLEX INSULATION**
How To Order

Small Diameter
Nickel Coated High-Strength
Copper Alloy Conductor

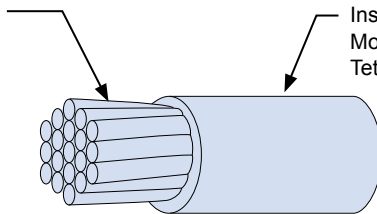

Insulation - Crosslinked, Extruded,
Modified ETFE (Ethylene-
Tetrafluoroethylene Copolymer)

Table I

Part Number	Wire Size (AWG)	Stranding (Number of strands x AWG gage of strands)	Diameter of stranded conductor (inches)		Finished Wire		
			min	max	Resistance at 20° C (68° F) (Ohms/1000 ft) max	Diameter (inches)	Weight (lbs/1000 ft) max
M22759/46-28-*	28	7 x 36	.014	.016	79.0	.027 ± .002	.91
M22759/46-26-*	26	19 x 38	.018	.020	49.4	.032 ± .002	1.4
M22759/46-24-*	24	19 x 36	.023	.025	30.1	.037 ± .002	2.0
M22759/46-22-*	22	19 x 34	.029	.031	18.6	.043 ± .002	2.8
M22759/46-20-*	20	19 x 32	.037	.039	11.4	.050 ± .002	4.3

M22759/46
Nickel Coated High Strength Copper Wire
with Crosslinked, Extruded ETFE Insulation



Table II: Test Data	
Temperature Rating	200° C (392° F) maximum continuous conductor temperature
Voltage Rating	600 volts (rms) at sea level
Short Term Thermal Stability	7 hours at 230 ± 2° C (446 ± 3.6° F). Quality conformance test, group II; test procedures and requirements as in life cycle test except for time and temperature of oven exposure.
Spark Test of Primary Insulation	not applicable
Impulse Dielectric Test	100% test, 8.0 kilovolts (peak)
Insulation Thickness	0.005 inch (min)
Insulation Resistance, Initial	5,000 megohms for 1000 ft (min)
Physical Properties of Insulation	pulled at 2 inches per minute. tensile strength, 5,000 lbf/in ² (min.) elongation, 75% (min.)
Propellant Resistance	no dielectric breakdown.
Crosslinking Proof Test	7 hours at 300° C ± 3° C (572 ± 5.4° F). Quality conformance test, group II. Requirements and procedures as for life cycle except for time and temperature.
Wrap Test	"wrap back" test. Oven temperature: 313 ± 3° C (595 ± 5.4° F)
Blocking	230 ± 3° C (446 ± 5.4° F)
Shrinkage	0.125 inch max at 230 ± 3° C (446 ± 5.4° F)
Wicking	not applicable
Solderability	not applicable
Low Temperature (Cold Bend)	bend temperature: -65° ± 3° C (-85 ± 5.4° F) dielectric test: 2,500 volts (rms), 60 Hz
Thermal Shock Resistance	oven temperature: 200 ± 3° C (392 ± 5.4° F) max change in measurement: 0.060 in
Flammability	quality conformance test, group II.
Life Cycle	500 hours at 230° C ± 3° C (446 ± 5.4° F). Dielectric test, 2,500 volts (rms), 60 Hz. Procedure to use mandrels coated with PTFE in the form of either enamel or wrapped tape, such that the diameter of the mandrels, after coating, still conform to the requirements of performance details.
Dielectric Test After Immersion	2,500 volts (rms), 60 Hz
Acid Resistance	no requirement
Conductor Strand Adhesion Requirements	shall be in accordance with 3.6.11 of MIL-W-22759
Abrasion Resistance After Immersion	no requirement
Humidity Resistance	after humidity exposure, wire shall meet the requirements for initial insulation resistance.
Surface Resistance	500 megohms - inches (min), initial and final readings
Smoke	250° C ± 5° C (482° ± 9° F); no visible smoke.
Color	in accordance with MIL-STD-104, class 1; white preferred. Conformity of color to the limits of MIL-STD-104 shall not be required after crosslinking proof test or life cycle oven exposure.
Color Striping or Banding Durability	125 cycles (250 strokes) minimum, 500 grams weight
Identification of Product	not required for size 24 and smaller. color code designator not required.
Identification Durability	125 cycles (250 strokes) minimum, 500 grams weight
Wire Length Requirements	schedule B

Notes

Cable identified with manufacturer's name and part number.
 Cable is sold in 1 foot increments. Specify desired length on purchase order.

**GENERAL PURPOSE, HIGH-STRENGTH, HARSH ENVIRONMENT, HIGH-TEMPERATURE RESISTANCE;
HIGH DURABILITY**

How To Order

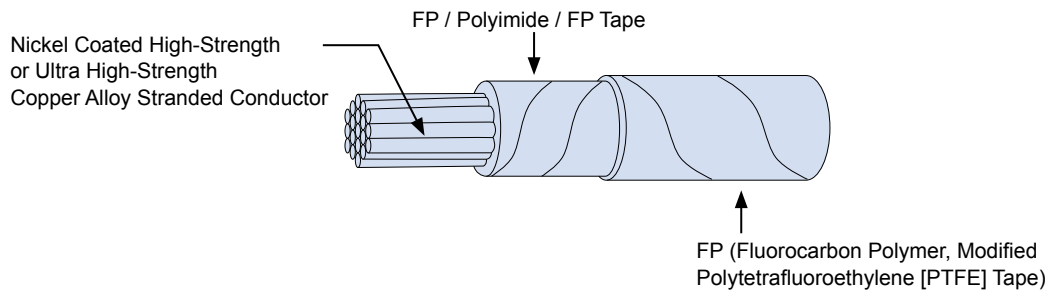
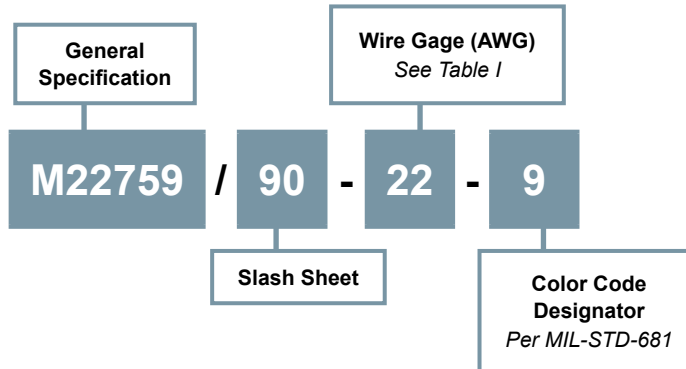

Table I

Part Number	Wire Size (AWG)	Stranding (Number of strands x AWG gage of strands)	Diameter of stranded conductor (inches)		Resistance at 20° C (68° F) (Ohms/1000 ft) max	Finished Wire				
			min	max		Diameter (inches)		Weight (lbs/1000 ft)		
						min	max	min	target	max
M22759/90-26-*	26	19 x 38	0.0175	0.0204	58.4	0.033	0.037	1.34	1.47	1.60
M22759/90-24-*	24	19 x 36	0.0225	0.0254	30.1	0.038	0.042	1.87	2.04	2.20
M22759/90-22-*	22	19 x 34	0.0285	0.0314	18.6	0.043	0.047	2.70	2.90	3.10
M22759/90-20-*	20	19 x 32	0.0365	0.0404	11.4	0.051	0.055	4.25	4.45	4.65

M22759/90
Nickel Coated High Strength Copper Wire
with Double Layer Tape Wrap Insulation



Table II: Test Data	
Temperature Rating	260° C (500° F) maximum continuous conductor temperature.
Voltage Rating	600 volts (RMS) at sea level
Color	white is the preferred color and shall be in accordance with MIL-STD-104, class 2. Colors shall be laser markable and meet the color limits defined. Conformity of color shall not be required after oven exposure.
Color Striping or Banding Durability	125 cycles (250 strokes), 250 grams weight
Continuous Lengths	Schedule B
Flammability Test	In accordance with AS4373, method 801 Requirements: Duration of after-flame 3 seconds max Flame travel 3.0 inches max No flaming of tissue
High Frequency Spark Test	(When used in lieu of impulse dielectric test) Test in accordance with AS4373, method 505, 5.7 kilovolts (RMS). Test 100% of the wire.
Humidity Resistance	After humidity exposure, wire shall meet the requirements for initial insulation resistance.
Identification Durability	125 cycles (250 strokes), 250 grams weight
Impulse Dielectric Test	8.0 kilovolts (peak). Test 100% of the wire
Insulation Resistance	5000 Megohms for 1000 feet (minimum)
Insulation State of Sinter	Quality conformance inspection performed on one sample per lot. Evaluate FP layers with a differential scanning calorimeter per AS4373, method 813. The difference in energy to melt between the first and second heats shall be less than or equal to 3 joules/gram.
Lamination Sealing	Group II quality conformance test. When tested in accordance with AS 4373, method 809 at 260° C for 6 hours. There shall be no evidence of tape separation or lifting. Three samples per lot shall be tested.
Life Cycle	500 hours at 290° C ± 2° C (554° F ± 3.6° F) Dielectric test, 2500 volts (RMS), 60 Hz. Use mandrels coated with PTFE such that the diameter of the mandrels after coating still conform to the required test mandrels diameters of table 6. After oven exposure, layers shall not separate and/or tapes shall not lift along the insulation or at the ends.
Low Temperature (Cold Bend)	Use mandrels and weights specified in Table 6. Chamber temperature -65° C ± 2° C (-85° F ± 3.6° F) Dielectric test, 2500 volts (RMS), 60 Hz
Shrinkage	.091 inch (max) at 290° C ± 2° C (554° F ± 3.6° F)
Smoke	260° C ± 5° C (500° F ± 9° F); no visible smoke
Solderability	Not required.
Strippability	Group II quality conformance test. After stripping with tools as defined in AS22759 and AS5457, no fragments of any layer shall extend more than .031 inches beyond the end of the polyimide tape layer.
Insulation Strip Force	Group II quality conformance test. Test in accordance with ASTM D 3032 section 27. The length of the insulation slugs shall be .25 inches. There shall be no evidence of insulation left on the conductor when viewed with the naked eye. Strip force: 0.25lb (min), 6.0lb (max)
Tape Overlap	In accordance with MIL-STD-2223, method 6005
Tensile Modulus	Test composite film in accordance with ASTM D 882, method A
Thermal Shock Resistance	Oven temperature 260° C ± 5° C (500° F ± 9° F), maximum change in measurement, .091 inches. No cracking.

Notes

Cable identified with manufacturer's name and part number.
 Cable is sold in 1 foot increments. Specify desired length on purchase order.

100 OHM MATCHED-IMPEDANCE CABLE

LIGHTWEIGHT QUADRAX CABLE FOR AEROSPACE APPLICATIONS

High-speed transmission solutions for 10/100/1000BASE-T Ethernet applications

No Dollars
or Quantity
Minimum orders

**NO
MINS.**



Glenair offers Quadrax contacts for use with MIL-DTL-38999 Series I, II, III and IV connectors, as well as for use with Glenair designed connectors such as our Series 28 HiPer-D and our Series 80 Mighty Mouse. Compatible cables for use with these connectors and others such as ARINC 628, 629 and 664 are now available from Glenair with no minimum order quantity and available in-house termination services. Glenair Quadrax cables incorporate extruded/expanded PTFE as the dielectric insulator, with high-durability PTFE or FEP jacketing. Our Quadrax cable is resistant to a broad range of temperatures up to +200°C, and has been employed successfully in a wide range of high-speed 10/100/1000BASE-T Ethernet as well as FibreChannel and IEEE1394 aerospace applications.



Glenair, Inc.
1211 Air Way
Glendale, CA
91201-2497
818-247-6000
sales@glenair.com
www.glenair.com

High-Speed/High-Frequency Contacts for use with Quadrax Cable



Size 8 Quadrax Pin



Size 8 Quadrax Socket

Quadrax Cable Selection Guide



Quadrax



Quadrax cables for use with appropriate Quadrax contacts and connectors all share the following features: 100 ohm and 150 ohm performance, -65°C to +200°C, low outgassing PTFE and FEP materials, Low smoke and low toxicity. Selections are chosen for lightweight flexibility and durability in ruggedized applications. The use of extruded, expanded PTFE as the dielectric provides the best time delay performance and the lowest loss. The result is lower attenuation and a larger bandwidth. Exceeds Requirements of FAR 25.869

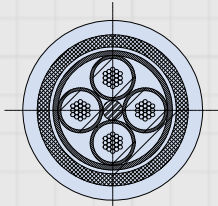

963-019

100 Ohm Ethernet Cable with 22 AWG Conductors, FEP Jacket

C-4

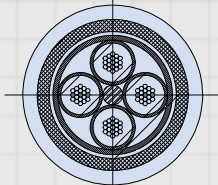

963-020

100 Ohm Ethernet Cable with 24 AWG Conductors , FEP Jacket

C-5

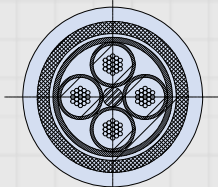

963-021

100 Ohm Ethernet Cable with 26 AWG Conductors , FEP Jacket

C-6

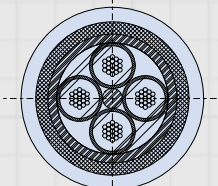

963-022

100 Ohm Ethernet Cable with 24 AWG Conductors, FEP Jacket,
Without PTFE Binder

C-7

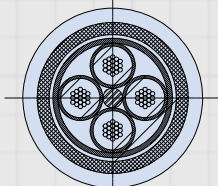

963-023

100 Ohm Ethernet Cable with 24 AWG Conductors, ETFE Jacket

C-8

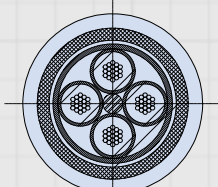

963-024

100 Ohm Ethernet Cable with 26 AWG Conductors, ETFE Jacket

C-9

C



MIL-DTL-38999 Insert Arrangements for Keyed Quadrax Contacts

SPECIAL CONTACT ARRANGEMENTS FOR QUADRAX CONTACTS

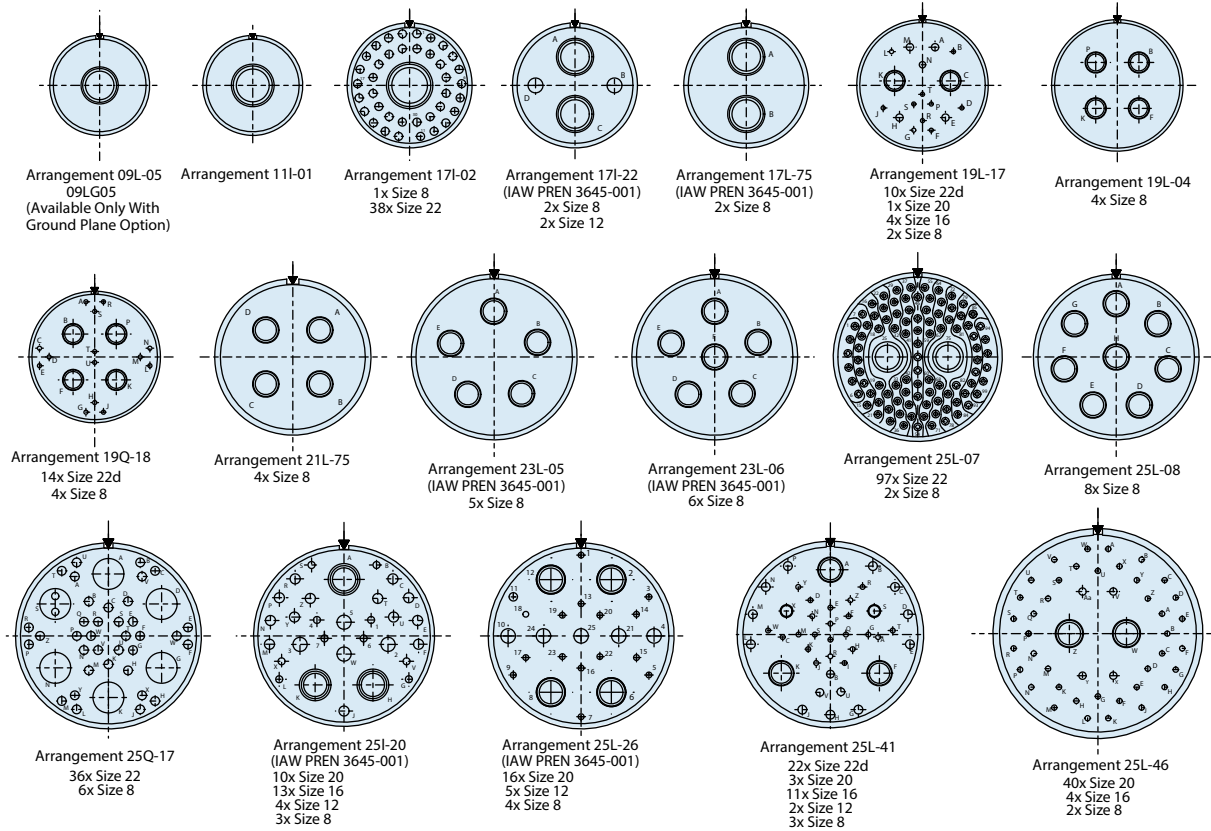

About Keyed Contacts

All connectors intended for use with size #8 contacts have an alignment slot inside the contact cavity. Quadrax contacts have an alignment key to properly orient the contact.

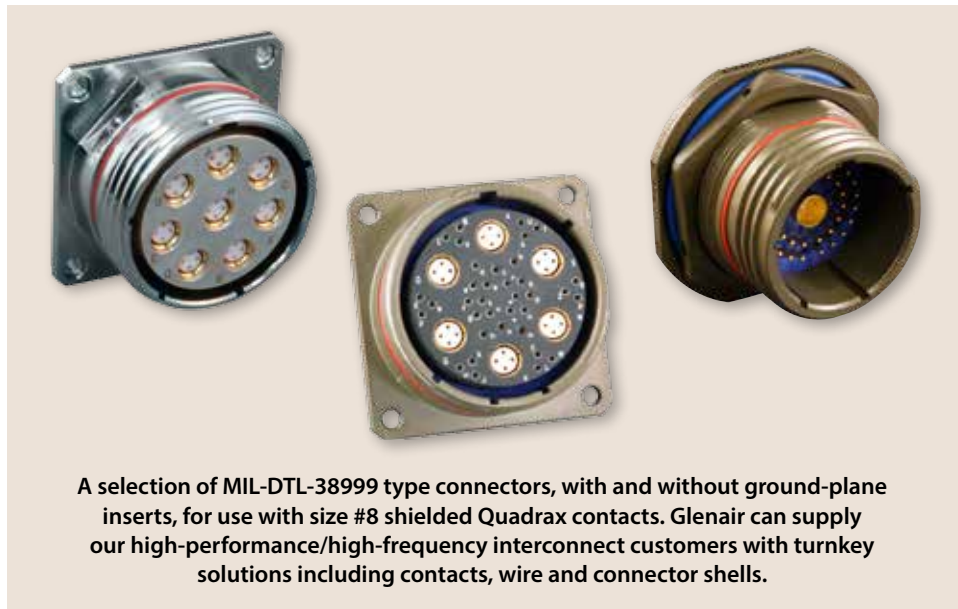
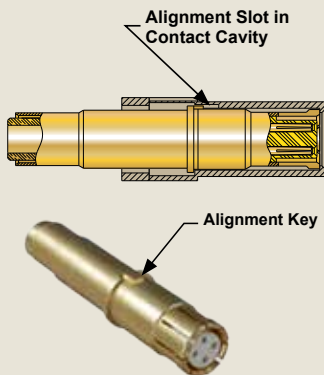

A selection of MIL-DTL-38999 type connectors, with and without ground-plane inserts, for use with size #8 shielded Quadrax contacts. Glenair can supply our high-performance/high-frequency interconnect customers with turnkey solutions including contacts, wire and connector shells.

Series 80 Mighty Mouse New Size #8 Contact Arrangements



Quadrap

Now available – Mighty Mouse connectors with industry-standard size 8 Quadrap contacts

New Mighty Mouse connectors have size #8 snap-in, rear-release contacts for power and data applications. Available with 1, 2, 3, 4 or 5 contacts, these connectors meet the need for a low-profile, lightweight connector compatible with size #8 twinax, quadrap and coax contacts used in MIL-DTL-38999 connectors. Quadrap contacts are 100 ohm impedance for Ethernet applications.

- Size #8 contacts
- 1, 2, 3, 4 or 5 contacts
- Snap-in, rear-release
- Quadrap or Differential Twinax contacts
- Lightweight, low profile
- Series 801 (double-start) and 805 (triple-start) Mighty Mouse connectors

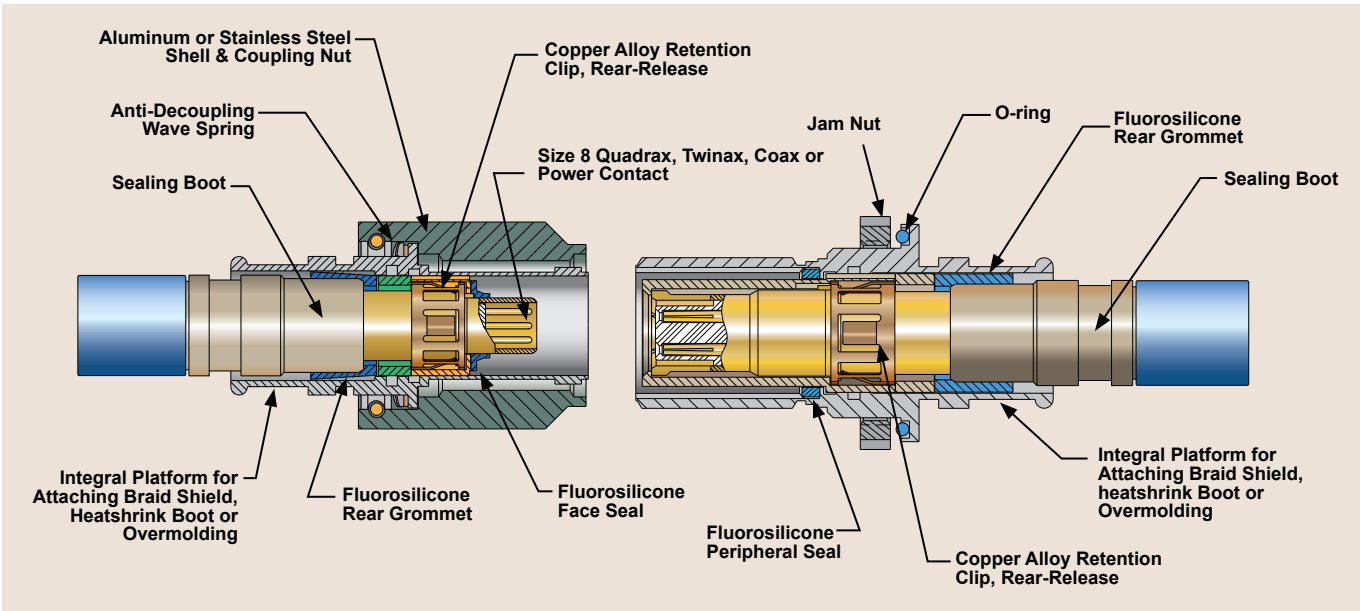

New Mighty Mouse #8 Contact Arrangements

Mating Face					
Series 801	8-1	16-2	17-3	19-4	21-5
Series 805	10-1	18-2	19-3	21-4	23-5





963-019

22 AWG Quadrax Cable, FEP Jacket
Tensolite NF22Q100

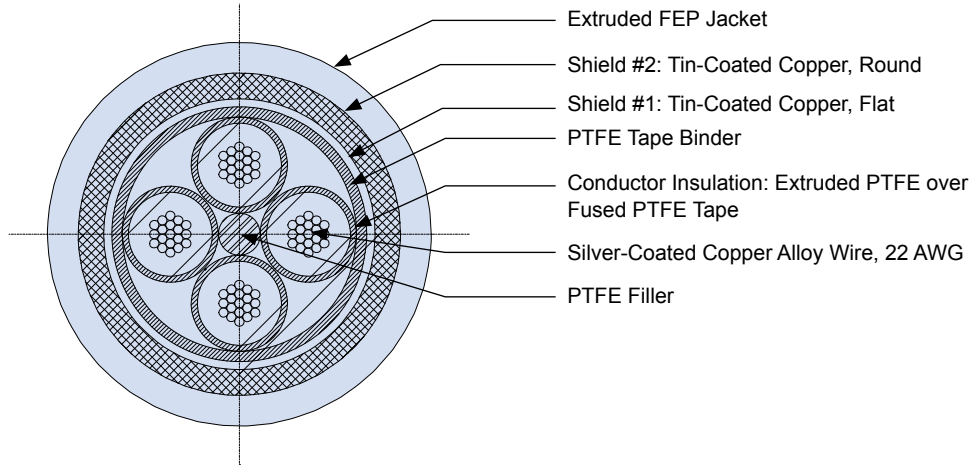
963-019 100 OHM ETHERNET CABLE WITH 22 AWG CONDUCTORS



Cable Material and Specifications		
Conductor AWG	22	
Conductor Material	Silver coated copper alloy	
Conductor Diameter (nom)	.0295"	
Insulation Material	ePTFE/PTFE	
Insulation Diameter (nom)	.055"	
Cable Diameter (nom)	.190"	
Cable Weight (lbs/1000 ft)	34	
Impedance	100	
Capacitance (pF/ft)	13	
Velocity of Propagation	79%	
Max Delay Skew (ps/ft)	137	
	10 MHz	100 MHz
Nominal/Maximum Attenuation (dB/100ft)	1.8/2.2	6.4/7.3
Min NEXT (dB)	50	35
Min SRL (dB)	23	16
Cable Budget Length to meet CAT5 Requirements	300 ft (91m)	

Compatible Contacts*	
 Size 8 Quadrax Pin 854-001-05	 Size 8 Quadrax Socket 854-002-05

*IAW pending AS39029/119 and /120

Notes

Cable marked with "NF22Q100 D 92607"
Wire pair color: red/blue, green/yellow.
Cable is sold in 1 foot increments.

963-020
24 AWG Quadrax Cable, FEP Jacket
Tensolite NF24Q100



963-020 100 OHM ETHERNET CABLE WITH 24 AWG CONDUCTORS

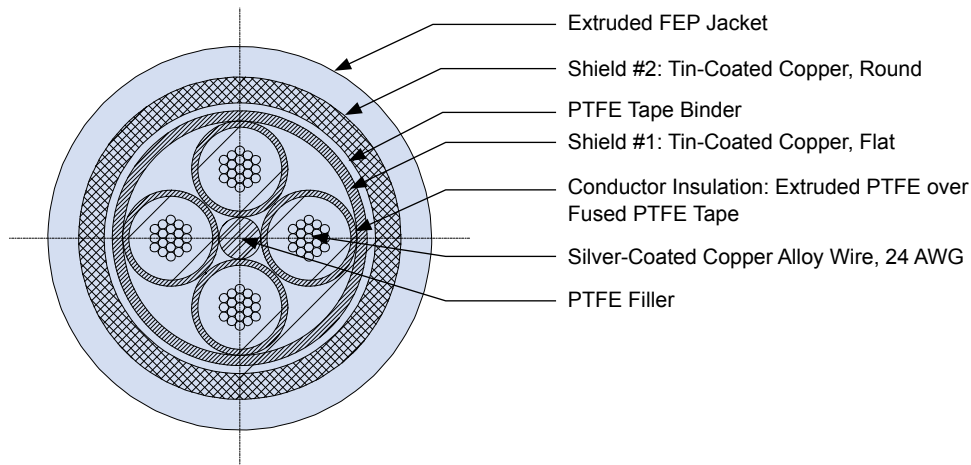

Cable Characteristics		
Conductor AWG	24	
Conductor Material	Silver coated copper alloy	
Conductor Diameter (nom)	.0233"	
Insulation Material	ePTFE/PTFE	
Insulation Diameter (nom)	.045"	
Cable Diameter (nom)	.163"	
Cable Weight (lbs/1000 ft)	24.5	
Impedance	100	
Capacitance (pF/ft)	13	
Velocity of Propagation	79%	
Max Delay Skew (ps/ft)	137	
	10 MHz	100 MHz
Nominal/Maximum Attenuation (dB/100ft)	2.3/2.7	8.0/9.2
Min NEXT (dB)	47	32
Min SRL (dB)	23	16
Cable Budget Length to meet CAT5 Requirements	240 ft (73m)	

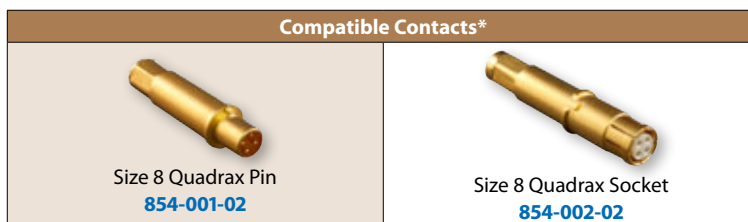

*IAW pending AS39029/119 and /120

Notes

Cable marked with "NF24Q100 D 92607"
Wire pair color: red/blue, green/yellow.
Cable is sold in 1 foot increments.





963-021

26 AWG Quadrax Cable, FEP Jacket
Tensolite NF26Q100

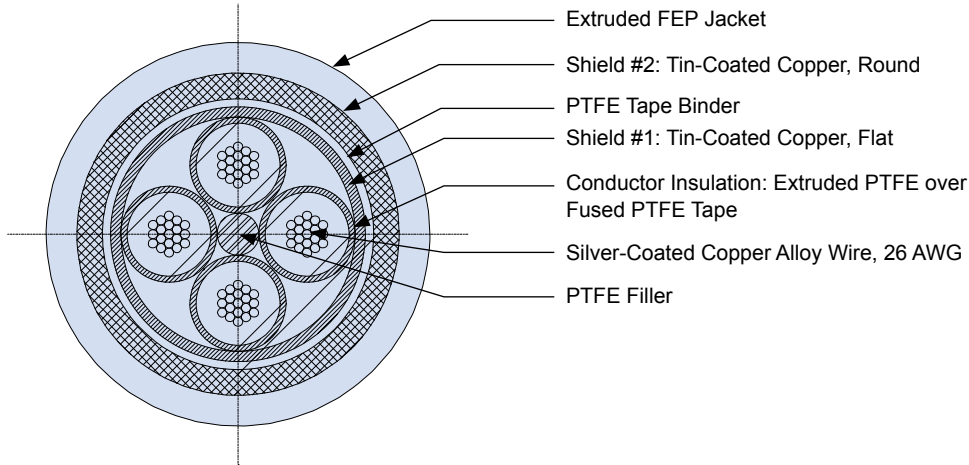
963-021 100 OHM ETHERNET CABLE WITH 26 AWG CONDUCTORS



Cable Characteristics		
Conductor AWG	26	
Conductor Material	Silver coated copper alloy	
Conductor Diameter (nom)	.0189"	
Insulation Material	ePTFE/PTFE	
Insulation Diameter (nom)	.038"	
Cable Diameter (nom)	.137"	
Cable Weight (lbs/1000 ft)	18	
Impedance	100	
Capacitance (pF/ft)	13	
Velocity of Propagation	79%	
Max Delay Skew (ps/ft)	137	
	10 MHz	100 MHz
Nominal/Maximum Attenuation (dB/100ft)	2.8/3.2	9.6/11.0
Min NEXT (dB)	50	35
Min SRL (dB)	23	16
Cable Budget Length to meet CAT5 Requirements	200 ft (61m)	

Compatible Contacts*	
 Size 8 Quadrax Pin 854-001-01	 Size 8 Quadrax Socket 854-002-01

*IAW pending AS39029/119 and /120

Notes

Cable marked with "NF26Q100 D 92607"
Wire pair color: red/blue, green/yellow.
Cable is sold in 1 foot increments.

963-022
24 AWG Quadrax Cable, FEP Jacket, Without PTFE Binder
PIC E50424



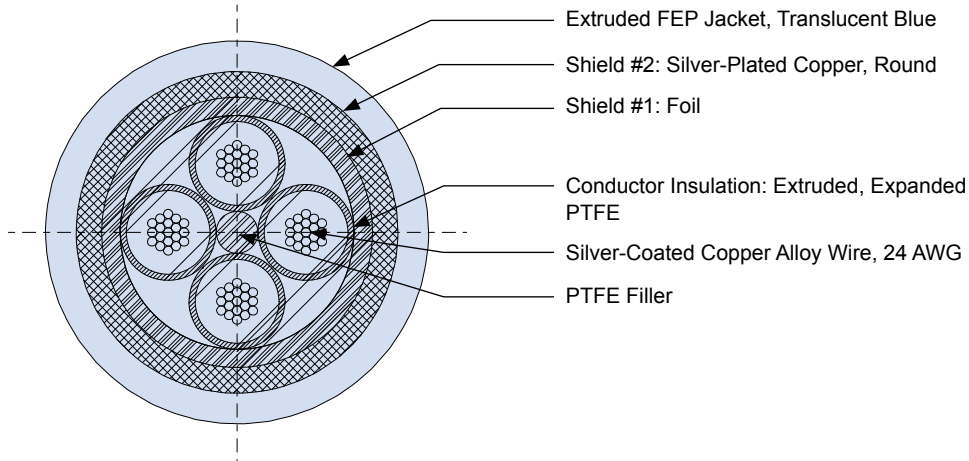

963-022 100 OHM ETHERNET CABLE WITH 24 AWG CONDUCTORS, NO PTFE BINDER



Physical Characteristics	
Conductors	24 AWG Stranded, silver plated copper alloy
Shield Coverage	100% (foil) 85% (braid)
Temperature Rating	-55° to +200°C
Outer Diameter (Inches)	0.170
Minimum Bend Radius (Inches)	1.00
Weight (Pounds/100 ft.)	3.5
Color Codes	red, blue, green, yellow

Electrical Performance			
Impedance (Ohms)	100		
Capacitance (pF/ft.)	13.0		
Velocity of Propagation	69.5%		
Dielectric Voltage Rating (KV RMS)	1.5		
DC Resistance (Ohms/100ft) Max	2.42		
	Attenuation (db/100 ft.) Max	Structural Return Loss (SRL) Min	Near-End Cross Talk (NEXT) (dB) Min
@ 10 MHz	-2.2	-23.0	-50.3
@ 100 MHz	-7.5	-16.0	-35.3

Compatible Contacts*	
 Size 8 Quadrax Pin 854-001-02	 Size 8 Quadrax Socket 854-002-02

*IAW pending AS39029/119 and /120

Notes
 Skydrol resistant, RoHS compliant, and passes FAA flammability requirements of FAR Part 23 and 25, Appendix F. Test results available upon request. Cable is sold in 1 foot increments.



963-023

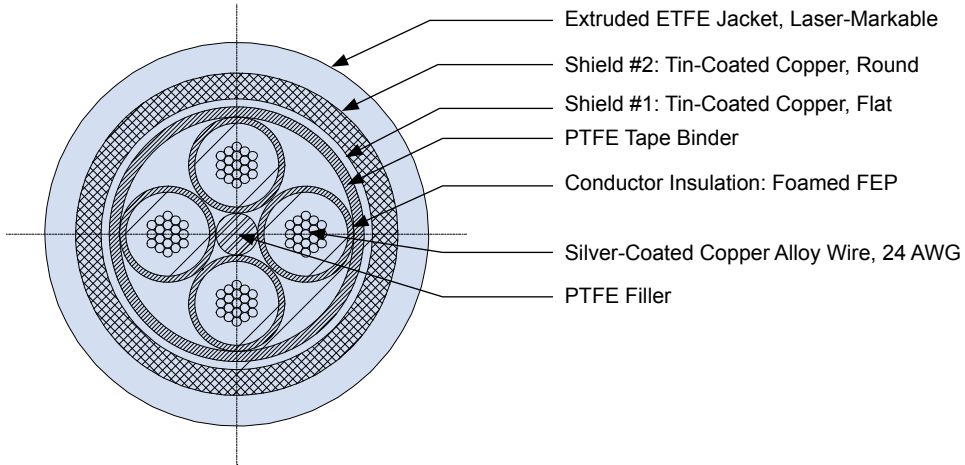

24 AWG Quadrax Cable, ETFE Jacket
PIC E51424

963-023 100 OHM ETHERNET CABLE, EXTRUDED ETFE JACKET, WITH 24 AWG CONDUCTORS



Physical Characteristics	
Conductors	24 AWG Stranded, silver plated copper alloy
Shield Coverage	100% (foil) 85% (braid)
Temperature Rating	-55° to +150°C
Outer Diameter (Inches)	0.161
Minimum Bend Radius (Inches)	0.80
Weight (Pounds/100 ft.)	2.2
Color Codes	red, blue, green, yellow

Electrical Performance			
Impedance (Ohms)	100		
Capacitance (pF/ft.)	13.0		
Velocity of Propagation	80.0%		
Dielectric Voltage Rating (KV RMS)	1.5		
DC Resistance (Ohms/100ft) Max	2.62		
	Attenuation (dB/100 ft.) Max	Structural Return Loss (SRL) Min	Near-End Cross Talk (NEXT) (dB) Min
@ 10 MHz	-2.7	-23.0	-50.3
@ 100 MHz	-9.2	-16.0	-35.3
@ 250 MHz	11.0 (nominal)	-16.0	-25.0

Compatible Contacts*	
 Size 8 Quadrax Pin 854-001-02	 Size 8 Quadrax Socket 854-002-02

*IAW pending AS39029/119 and /120

Notes

Skydrol resistant, RoHS compliant, and passes FAA flammability requirements of FAR Part 23 and 25, Appendix F. Test results available upon request. Cable is sold in 1 foot increments.

963-024
26 AWG Quadrax Cable, ETFE Jacket
PIC E51426



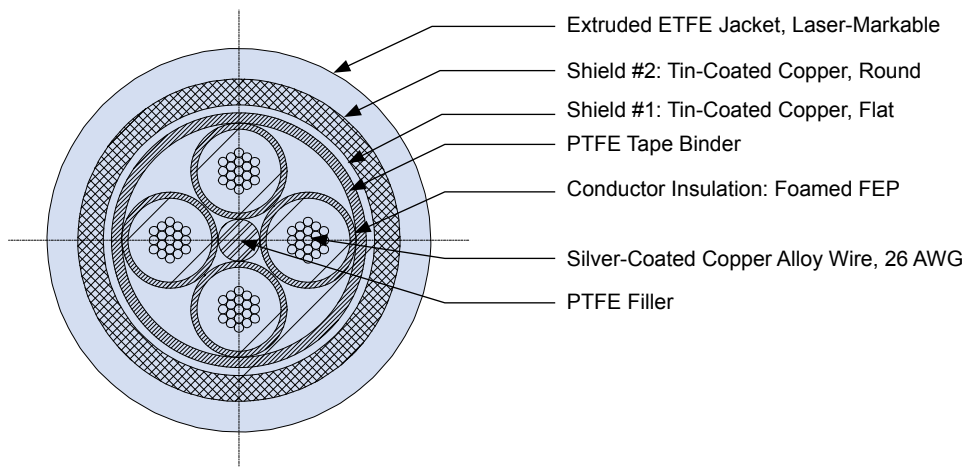

963-024 100 OHM ETHERNET CABLE, EXTRUDED ETFE JACKET, WITH 26 AWG CONDUCTORS



Physical Characteristics	
Conductors	26 AWG Stranded, silver plated copper alloy
Shield Coverage	100% (foil) 85% (braid)
Temperature Rating	-55° to +150°C
Outer Diameter (Inches)	0.137
Minimum Bend Radius (Inches)	0.685
Weight (Pounds/100 ft.)	1.8
Color Codes	red, blue, green, yellow

Electrical Performance			
Impedance (Ohms)	100		
Capacitance (pF/ft.)	13.0		
Velocity of Propagation	70.0%		
Dielectric Voltage Rating (KV RMS)	1.5		
DC Resistance (Ohms/100ft) Max	4.48		
	Attenuation (db/100 ft.) Max	Structural Return Loss (SRL) Min	Near-End Cross Talk (NEXT) (dB) Min
@ 10 MHz	-3.2	-23.0	-50.3
@ 100 MHz	-11.0	-16.0	-35.3

Compatible Contacts*	
 Size 8 Quadrax Pin 854-001-01	 Size 8 Quadrax Socket 854-002-01

*IAW pending AS39029/119 and /120

Notes

Skydrol resistant, RoHS compliant, and passes FAA flammability requirements of FAR Part 23 and 25, Appendix F. Test results available upon request. Cable is sold in 1 foot increments.

SERIES 962

HIGH-PERFORMANCE COAXIAL CABLE

MIL-C-17 QPL and commercial



Glenair high-performance Coax cables are constructed with silver plated conductors, insulated with fluoropolymer material, and finished with single or double layers of conductive shielding and appropriate jacket. Ideally suited for demanding military and commercial aerospace applications, these cables offer stable, predictable electrical performance under rugged mechanical and environmental conditions including repeated flexing, abrasion abuse, vibration, extreme temperatures, and exposure to aerospace fluids and chemicals. Glenair cable and contact engineers are available to review specific program requirements including environmental challenges, frequency requirements, loss budget, VSWR, and so on to select the most appropriate cable for every application.

High-Performance Contacts for use with Coax Cable



Coax Pin

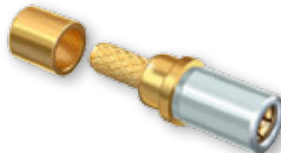

Coax Socket

Glenair®

Glenair, Inc.
1211 Air Way
Glendale, CA
91201-2497
818-247-6000
sales@glenair.com
www.glenair.com

Coaxial Cable



Coaxial cable has an inner conductor surrounded by a tubular insulating layer, surrounded by a tubular conducting shield. All our coaxial cables also have an insulating outer sheath or jacket. The term coaxial comes from the inner conductor and the outer shield sharing a geometric axis. Coaxial cable differs from other shielded cable used for carrying lower-frequency signals, such as audio signals, in that the dimensions of the cable are controlled to give a precise, constant conductor spacing, which is needed for it to function efficiently as a radio frequency transmission line.



962-001

TFlex® Low Loss Microwave 50 Ohm Coaxial Cable

D-4



962-002

M17/93 - RG178 General-Duty 50 Ohm High-Frequency Coaxial Cable with Extended Temperature Range

D-6



962-003

M17/94 - RG179 75 Ohm High-Frequency Coaxial Cable with Extended Temperature Range

D-7



962-004

M17/113 - RG316 Low-Loss 50 Ohm High Frequency Coaxial Cable with Extended Temperature Range

D-8



962-005

M17/152-00001 (RG316-DS) Double Shield 50 Ohm Coaxial Cable with Extended Temperature Range

D-9





High-Performance Coaxial Contact Cross-Reference

Military Part Number	Glenair Part Number	Contact Size	Pin / Socket	Type	BIN Color Striping		
					Color 1	Color 2	Color 3
M39029/27-210	852-001-12-210	12	Socket	Coaxial	Red	Brown	Black
M39029/27-402	852-001-12-402	12	Socket	Coaxial	Yellow	Black	Red
M39029/27-403	852-001-12-403	12	Socket	Coaxial	Yellow	Black	Orange
M39029/27-404	852-001-12-404	12	Socket	Coaxial	Yellow	Black	Yellow
M39029/27-405	852-001-12-405	12	Socket	Coaxial	Yellow	Black	Green
M39029/27-406	852-001-12-406	12	Socket	Coaxial	Yellow	Black	Blue
M39029/27-407	852-001-12-407	12	Socket	Coaxial	Yellow	Black	Violet
M39029/27-408	852-001-12-408	12	Socket	Coaxial	Yellow	Black	Gray
M39029/28-211	852-002-12-211	12	Pin	Coaxial	Red	Brown	Brown
M39029/28-409	852-002-12-409	12	Pin	Coaxial	Yellow	Black	White
M39029/28-410	852-002-12-410	12	Pin	Coaxial	Yellow	Brown	Black
M39029/28-411	852-002-12-411	12	Pin	Coaxial	Yellow	Brown	Brown
M39029/28-412	852-002-12-412	12	Pin	Coaxial	Yellow	Brown	Red
M39029/28-413	852-002-12-413	12	Pin	Coaxial	Yellow	Brown	Orange
M39029/28-414	852-002-12-414	12	Pin	Coaxial	Yellow	Brown	Yellow
M39029/28-415	852-002-12-415	12	Pin	Coaxial	Yellow	Brown	Green
M39029/59-366	852-006-08-366	08	Socket	Coaxial	Orange	Blue	Blue
M39029/60-367	852-007-08-367	08	Pin	Coaxial	Orange	Blue	Violet
M39029/75-416	852-003-12-416	12	Socket	Coaxial	Yellow	Brown	Blue
M39029/75-417	852-003-12-417	12	Socket	Coaxial	Yellow	Brown	Violet
M39029/75-418	852-003-12-418	12	Socket	Coaxial	Yellow	Brown	Gray
M39029/75-419	852-003-12-419	12	Socket	Coaxial	Yellow	Brown	White
M39029/75-420	852-003-12-420	12	Socket	Coaxial	Yellow	Red	Black
M39029/75-421	852-003-12-421	12	Socket	Coaxial	Yellow	Red	Brown
M39029/75-422	852-003-12-422	12	Socket	Coaxial	Yellow	Red	Red
M39029/75-423	852-003-12-423	12	Socket	Coaxial	Yellow	Red	Orange
M39029/76-424	852-008-16-424	16	Pin	Coaxial	Yellow	Red	Yellow
M39029/76-425	852-008-16-425	16	Pin	Coaxial	Yellow	Red	Green
M39029/76-426	852-008-16-426	16	Pin	Coaxial	Yellow	Red	Blue
M39029/76-427	852-008-16-427	16	Pin	Coaxial	Yellow	Red	Violet
M39029/77-428	852-009-16-428	16	Socket	Coaxial	Yellow	Red	Gray
M39029/77-429	852-009-16-429	16	Socket	Coaxial	Yellow	Red	White
M39029/77-430	852-009-16-430	16	Socket	Coaxial	Yellow	Orange	Black
M39029/77-431	852-009-16-431	16	Socket	Coaxial	Yellow	Orange	Brown
M39029/78-432	852-010-16-432	16	Socket	Coaxial	Yellow	Orange	Red
M39029/78-433	852-010-16-433	16	Socket	Coaxial	Yellow	Orange	Orange
M39029/78-434	852-010-16-434	16	Socket	Coaxial	Yellow	Orange	Yellow
M39029/78-435	852-010-16-435	16	Socket	Coaxial	Yellow	Orange	Green
M39029/102-558	852-004-12-558	12	Pin	Coaxial	Green	Green	Gray
M39029/103-559	852-005-12-559	12	Socket	Coaxial	Green	Green	White

MIL-DTL-38999 type and Series 80 Mighty Mouse Coaxial Contact Arrangements



Coaxial

COAXIAL CONTACTS

Shielded coaxial contacts have a special role in the interconnect system and are designed for use in a wide range of military and aerospace connectors that service analog radio frequency or microwave applications. Most Glenair cylindrical connectors, including our D38999 type, can accommodate shielded contacts. Rectangular connector packages, such as our high-performance HiPer-D are also ideally suited for these shielded contacts.

SPECIAL CONTACT ARRANGEMENTS FOR COAXIAL CONTACTS

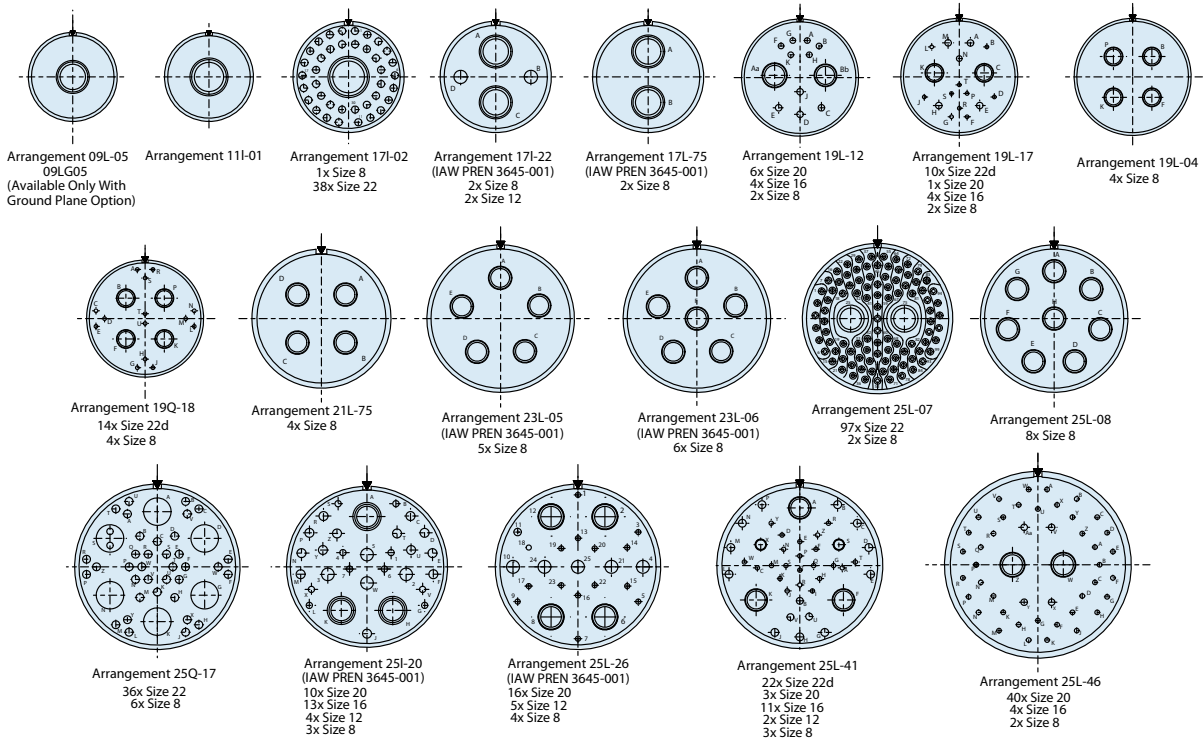

Series 80 Mighty Mouse Contact Arrangements with Size #12 and #16 Cavities for Coaxial Contacts												
Contact Size		Contact Quantity					Contact Arrangement					
		#23	#20	#20HD	#16	#12	Series 800	Series 801	Series 802	Series 803	Series 804	Series 805
Size #16 Coaxial Contacts 50-75 Ohms					7		12-7	13-7	12-7	12-7	12-7	15-7
					12		Not Avail.	16-12	14-12	14-12	14-12	18-12
					14		Not Avail.	17-14	15-14	Not Avail.	Not Avail.	19-14
					22		Not Avail.	21-22	21-22	Not Avail.	Not Avail.	23-22
Size #12 Contacts 23 Amp Max. Current 1800 VAC #12-#14 AWG						1	7-1	7-1	7-1	7-1	7-1	9-1
						2	10-2	10-2	10-2	10-2	10-2	12-2
						2	12-2	13-2	12-2	12-2	12-2	15-2
						3	12-3	13-3	12-3	12-3	12-3	15-3
Contact Arrangements with Mixed Size (Combo) Layouts		4			2		9-200	9-200	9-200	9-200	9-200	11-200
		8			2		10-202	10-202	10-202	10-202	10-202	12-202
		4				2	10-201	10-201	10-201	10-201	10-201	12-201
		6				2	12-200	13-200	12-200	12-200	12-200	15-200
		10				2	12-201	13-201	12-201	12-201	12-201	15-201
	12				1	10-200	10-200	10-200	10-200	10-200	12-200	



962-001 TFlex[®] Low Loss Microwave 50 Ohm Coaxial Cable

962-001 LOW-LOSS MICROWAVE, SHIELDED, OPTIMAL VSWR LEVELS

How To Order

Basic Part
Number

962-001

Dash Number

405 - TFlex[®]-405
402 - TFlex[®]-402
401 - TFlex[®]-401
047 - TFlex[®]-047

405

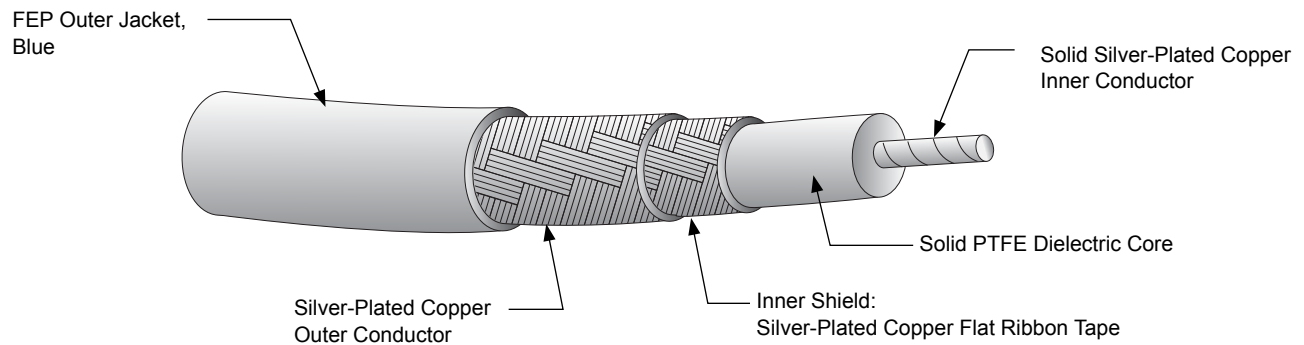

Features and Notes

- Excellent Shielding Effectiveness
 - Low Passive Intermod (PIM)
 - Stable Loss, Phase and VSWR vs. Flexing
 - Uses Standard Solder-on Semirigid Connectors
- Cable identified with manufacturer's name and part number.
Cable is sold in 1 foot increments. Specify desired length on purchase order.

962-001
TFlex® Low Loss Microwave
50 Ohm Coaxial Cable



Coaxial

Table I - Physical and Mechanical Specifications

	-405	-402	-401	-047
Dimensions (Inches)				
Conductor	0.0201	0.036	0.0641	0.0113
Dielectric	0.064	0.118	0.208	0.0370
Shield	0.085	0.139	0.249	0.057
Jacket	0.104	0.160	0.270	0.074
Minimum Static Bend Radius (In)	0.250	0.500	1.125	0.125
Weight (lbs/ft)	0.015	0.033	0.095	0.0075
Temperature Range	-65° C to +125° C			
Electrical Specifications				
Impedance	50 Ohms			
Velocity %	69.5			
Capacitance Per Foot	29.3			
Shielding	>100 dB			
Cutoff Frequency	60 GHz	34 GHz	19 GHz	108 GHz

Compatible Contacts



852-018

Size #12 D38999 Sr. II/Mighty Mouse Pin

852-025

D38999 Sr. I/III/IV Pin

852-036

D38999 Sr. I/III/IV Pin

852-071

D38999 Sr. I/III/IV Pin

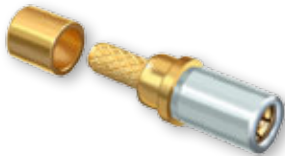

852-017

Size #12 D38999 Sr. II/Mighty Mouse Socket

852-024

D38999 Sr. I/III/IV Socket

852-032

D38999 Sr. II/Mighty Mouse Socket

852-035

D38999 Sr. I/III/IV Socket

852-037

D38999 Sr. I/III/IV Socket

852-070

D38999 Sr. I/III/IV Socket

Table II: Attenuation (dB per 100 feet at +25° C)

	-405	-402	-401	-047
Frequency Styles	0.104	0.160	0.270	0.074
100 MHz	6.4	3.4	2.2	12
400 MHz	13.1	7.1	4.7	24
1,000 MHz	21.1	11.6	7.8	37
2,000 MHz	31.0	17.0	12.0	53
3,000 MHz	38.0	22.0	15.0	66
10,000 MHz	75.0	45.0	33.0	124
12,000 MHz	83.0	51.0	37.0	137
13,500 MHz	89.0	55.0	41.0	145
16,000 MHz	99.0	61.0	46.0	160
18,000 MHz	106.0	66.0	50.0	170
Attenuation at Frequency	A = K1 FMHz + K2 FMHz			
K1	.630	.330	.210	1.156
K2	0.00120	0.00120	0.00120	0.00120

Table III: Maximum CW Power Handling (Watts at +40° C, sea level 1:1 VSWR)

	-405	-402	-401	-047
Frequency Size	0.104	0.160	0.270	N/A
100 MHz	401	999	2119	
400 MHz	195	480	1002	
1,000 MHz	119	290	595	
2,000 MHz	81	195	394	
3,000 MHz	65	154	306	
10,000 MHz	31	72	136	
12,000 MHz	28	63	120	
13,500 MHz	26	58	110	
16,000 MHz	23	52	97	
18,000 MHz	21	48	88	



962-002
M17/93 - RG178
General-Duty 50 Ohm Coaxial Cable

962-002 GENERAL-DUTY 50 OHM M17 HIGH-FREQUENCY CABLE WITH EXTENDED TEMPERATURE RANGE

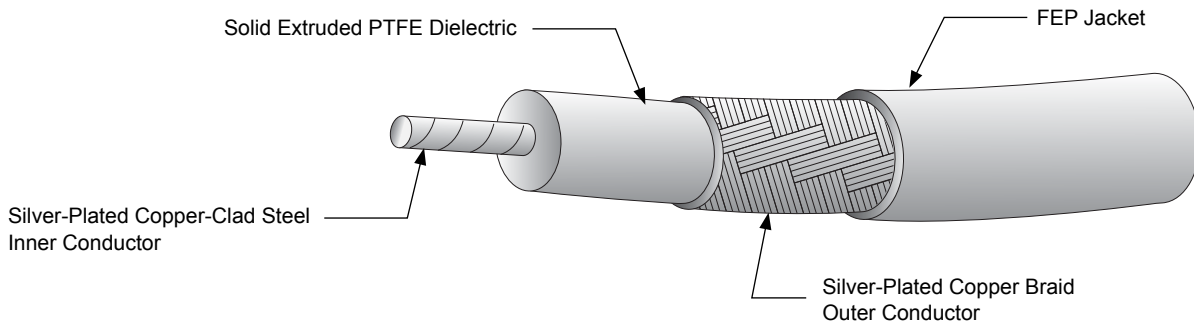

Physical and Mechanical Specifications

Dimensions (Inches)	
Center Conductor	$\varnothing .012 \pm .001$ (7 x .0004) silver plated copper clad steel
Dielectric Core	Solid PTFE extruded to $\varnothing .033 \pm .002$
Outer Conductor	38 AWG silver plated copper braid $\varnothing .054$ Max
Jacket	FEP to $\varnothing .071 \pm .004$
Operating Temperature	-55° C to +200° C

Electrical Specifications

Working Voltage	750 volts RMS (continuous)
Operating Frequency	3 GHz max
Velocity of Propagation	69.5% nominal
DC Resistance (Inner Conductor)	24.45 Ohm per 100 ft (max, at 20° C)
Spark Test	2,000 volts RMS +25%/-0%
DWV	2,000 volts RMS (minimum)
CEV	1,000 volts RMS (minimum)
Impedance	50 \pm 2 Ohms

Compatible Contacts



852-008

Size #16 D38999 Sr. I/III/IV Pin

852-016

Size #12 D38999 Sr. II/Mighty Mouse Pin



852-009

Size #16 D38999 Sr. I/III/IV Socket

852-010

Size #16 D38999 Sr. II/Mighty Mouse Socket

852-015

Size #12 D38999 Sr. II/Mighty Mouse Socket

Attenuation

MHz	dB per 100 ft
50	11.6
100	16
400	33
1,000	52
3,000	94

Structural Return Loss

MHz	dB
50	26
100	25
400	22
1,000	19
3,000	14

Notes

Cable identified with manufacturer's name and part number.
 Cable is sold in 1 foot increments. Specify desired length on purchase order.

962-003
M17/94 - RG179
75 Ohm Coaxial Cable



Coaxial

962-003 75 OHM M17 HIGH FREQUENCY CABLE WITH EXTENDED TEMPERATURE RANGE

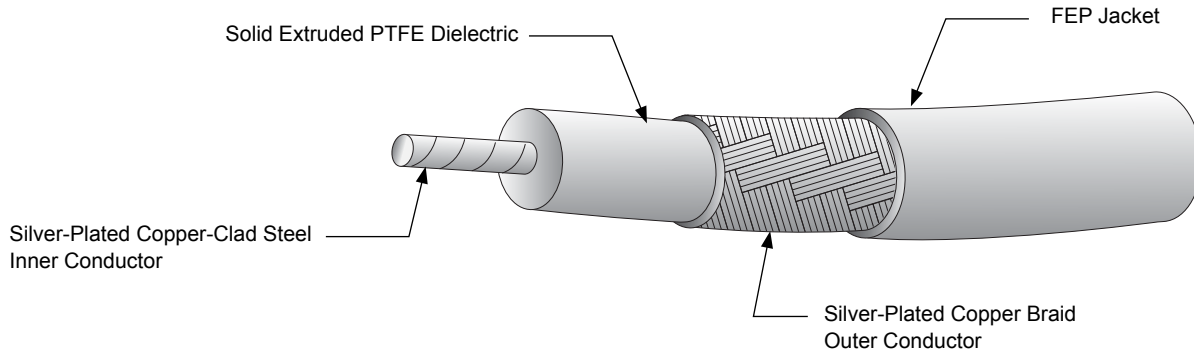

Physical and Mechanical Specifications	
Dimensions (Inches)	
Center Conductor	Ø .012 ± .001 (7 x .004) silver plated copper-clad steel
Dielectric Core	solid PTFE extruded to Ø.068 ± .003
Outer Conductor	38 AWG silver-plated copper braid, Ø.084 maximum Coverage: 92.3% nominal
Jacket	FEP to Ø.100 ± .005
Operating Temperature	-55° C to +200° C

Electrical Specifications	
Working Voltage	900 volts RMS (continuous)
Operating Frequency	3 GHz max
Velocity of Propagation	69.5% nominal
DC Resistance (Inner Conductor)	24.45 Ohm per 100 ft (max, at 20° C)
Spark Test	2,000 volts RMS +10%/-0%
DWV	2,000 volts RMS (minimum)
CEV	1,200 volts RMS (minimum)
Impedance	75 ± 3 Ohms
Attenuation	21.0 dB/100 ft maximum (0.4 GHz)
Capacitance	23.0 pf/ft maximum

Compatible Contacts



852-002
 Size #12 D38999 Sr. I/II/III/IV Pin

852-004
 Size #12 D38999 Sr. I/II/III/IV Pin

852-008
 Size #16 D38999 Sr. I/III/IV Pin

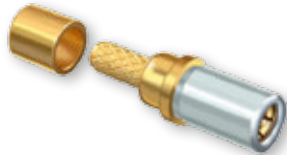

852-001
 Size #12 D38999 Sr. II/Mighty Mouse Socket

852-003
 Size #12 D38999 Sr. I/III/IV Socket

852-005
 Size #12 D38999 Sr. I/III/IV Socket

852-009
 Size #16 D38999 Sr. I/III/IV Socket

852-010
 Size #16 D38999 Sr. II/Mighty Mouse Socket

Notes

Cable identified with manufacturer's name and part number.
 Cable is sold in 1 foot increments. Specify desired length on purchase order.

D

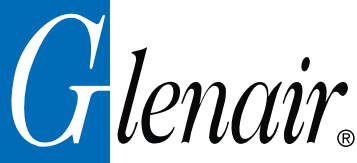

962-004
M17/113 - RG316
Low-Loss 50 Ohm Coaxial Cable

962-004 LOW-LOSS 50 OHM M17 HIGH FREQUENCY CABLE WITH EXTENDED TEMPERATURE RANGE

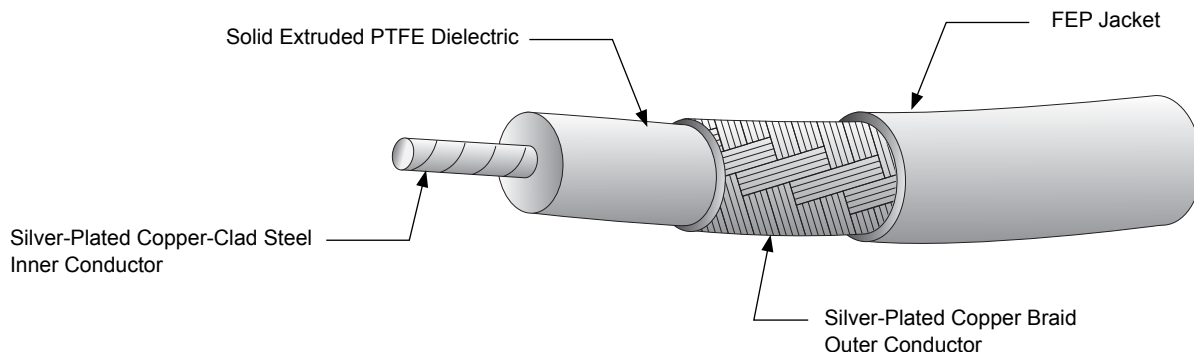

Physical and Mechanical Specifications

Dimensions (Inches)	
Center Conductor	Ø .0201 ± .001 (7 x .0067) silver plated copper-clad steel
Dielectric Core	solid PTFE extruded to Ø.060 ± .003
Outer Conductor	38 AWG silver-plated copper braid, Ø.081 maximum Coverage: 95.2% nominal
Jacket	FEP to Ø.098 ± .004
Operating Temperature	-55° C to +200° C

Compatible Contacts



852-002

Size #12 D38999 Sr. I/II/III/IV Pin

852-004

Size #12 D38999 Sr. I/II/III/IV Pin

852-008

Size #16 D38999 Sr. I/III/IV Pin

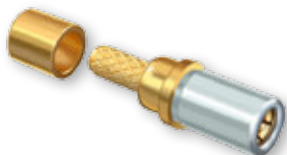

852-001

Size #12 D38999 Sr. II/Mighty Mouse
Socket

852-003

Size #12 D38999 Sr. I/III/IV Socket

852-005

Size #12 D38999 Sr. I/III/IV Socket

852-009

Size #16 D38999 Sr. I/III/IV Socket

852-010

Size #16 D38999 Sr. II/Mighty Mouse
Socket

Electrical Specifications

Working Voltage	900 volts RMS (continuous)
Operating Frequency	3 GHz max
Velocity of Propagation	69.5% nominal
DC Resistance (Inner Conductor)	8.41 Ohms/100 ft max (20° C)
Spark Test	2,000 volts RMS +25%/-0%
DWV	2,000 volts RMS (minimum)
CEV	1,200 volts RMS (minimum)
Impedance	50 ± 2 Ohms

Attenuation

MHz	dB per 100 ft
50	7.5
100	11
400	21
1,000	38
3,000	58

Structural Return Loss

MHz	dB
50	30
100	30
400	23
1,000	21
3,000	17

Notes

Cable identified with manufacturer's name and part number.
 Cable is sold in 1 foot increments. Specify desired length on purchase order.

962-005
M17/152-00001 (RG316-DS)
50 Ohm Ultra-High Frequency Coaxial Cable
with Double Shield



Coaxial

962-005 50 OHM M17 ULTRA-HIGH FREQUENCY CABLE WITH EXTENDED TEMPERATURE RANGE

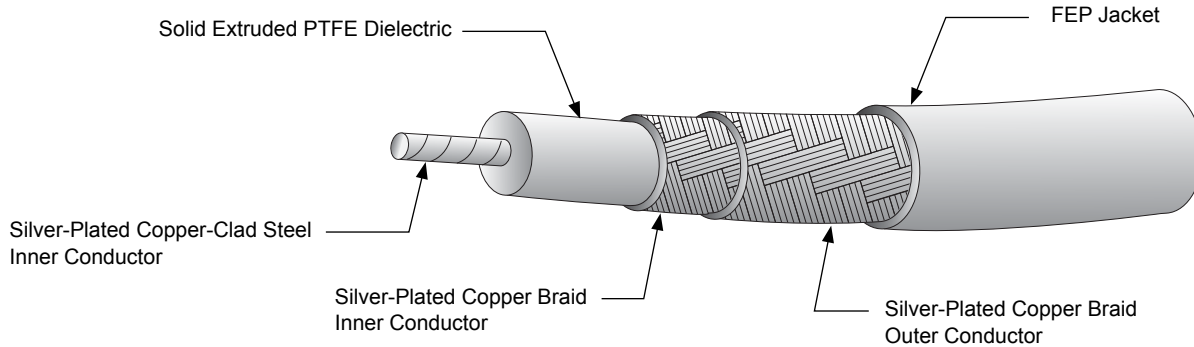

Physical and Mechanical Specifications	
Dimensions (Inches)	
Center Conductor	Ø .0201 ± .001 (7 x .0067) silver plated copper-clad steel
Dielectric Core	solid PTFE extruded to Ø.060 ± .003
Outer Conductor	38 AWG silver-plated copper braid, Ø.096 maximum Inner Braid: 95.4% nominal coverage Outer Braid: 94.6% nominal coverage
Jacket	FEP to Ø .114 ± .004
Operating Temperature	-55° C to +200° C

Electrical Specifications	
Working Voltage	900 volts RMS (continuous)
Operating Frequency	12.4 GHz max
Velocity of Propagation	69.5% nominal
DC Resistance (Inner Conductor)	8.41 Ohms/100 ft max (20° C)
Spark Test	2,000 volts RMS +10%/-0%
DWV	2,000 volts RMS (minimum)
CEV	1,200 volts RMS (minimum)
Impedance	50 ± 2 Ohms
Capacitance	32 pf/ft (minimum)

Structural Return Loss	
MHz	dB
500	26
3,000	20
12,400	15

Attenuation / Max Power		
MHz	dB per 100 ft	Watts
50	7.5	600
500	26	190
1,000	40	130
3,000	75	75
10,000	170	45
12,400	200	37

Compatible Contacts

852-016
Size #12 D38999 Sr. II/Mighty Mouse Pin

852-031
Size #8 D38999 Sr. I/III/IV Pin

852-015
Size #12 D38999 Sr. II/Mighty Mouse Socket

852-019
Size #12 D38999 Sr. III Socket

852-030
Size #8 D38999 Sr. I/III/IV Socket

Notes
 Cable identified with manufacturer's name and part number.
 Cable is sold in 1 foot increments. Specify desired length on purchase order.

POWER
DISTRIBUTION
CABLE

TURBOFLEX™

Ultra flexible, rugged power cable

No Dollars
or Quantity
Minimum orders

**NO
MINS.**



TurboFlex™ power distribution cables are fabricated from highly flexible conductors and high-performance insulation to produce cables ideally suited for applications where flexibility, durability, and weight reduction are required. Amazingly light and flexible—especially in cold weather—the 12 AWG – 450 MCM TurboFlex™ cable features rope lay inner conductors from either copper, tin-copper, or silver and nickel copper materials. TurboFlex also features Glenair's unique Duraelectric™ jacket material that offers outstanding flexibility, performance, and resistance to environmental and caustic chemical exposure. Duraelectric is also halogen-free, flame resistant and has a low smoke index appropriate for interior applications. Long life and performance are critical in power distribution applications. TurboFlex™ with its flexible conductors and durable jacket material delivers both. Contact the factory for a sample.

TurboFlex™ cable is optimized for use with Series 970 PowerTrip™ connectors and LouverBand contacts



High-Performance LouverBand™ Contacts



LouverBand™ Pin



LouverBand™ Socket

Glenair®

Glenair, Inc.
1211 Air Way
Glendale, CA
91201-2497
818-247-6000
sales@glenair.com
www.glenair.com

TurboFlex™
Ultra-Flexible Power Transmission Wire
Selection Guide

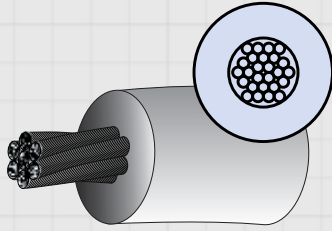

961-001

TurboFlex Power Cable with .125" Duraelectric™ Jacket
4500 VAC

E-6

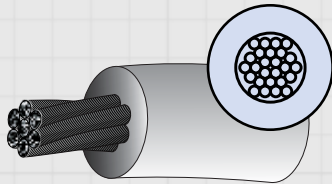

961-002

TurboFlex Power Cable with .093" Duraelectric™ Jacket
3500 VAC

E-7

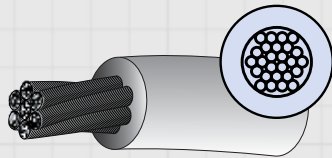

961-003

TurboFlex Power Cable with .062" Duraelectric™ Jacket
3000 VAC

E-8

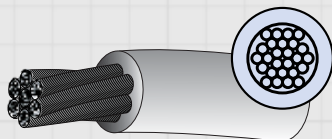

961-004

TurboFlex Power Cable with .032" Duraelectric™ Jacket
2000 VAC

E-9





TurboFlex™

Ultra-Flexible Power Distribution Cable

Product Showcase • Voltage Rating Data

The heart of TurboFlex™ power distribution cable is its ultra-flexible, ultra-fine wire conductor. TurboFlex™ power leads and flexible power transmission cables are made from bare copper, tin/copper, silver/copper or nickel/copper. Each material offers unique electrical performance, including current-carrying capability and temperature range. Ultra-flexible stranded bare copper or silver-plated copper conductors provide optimal conductivity. Tin/copper conductors offer superior solderability, and nickel/copper conductors offer superior corrosion resistance. All TurboFlex™ conductor materials deliver maximum flexibility and ability to handle the high voltage and temperature ranges inherent in such applications as military vehicles, aerospace ground support systems, and charging stations. Duraelectric™, the TurboFlex jacketing delivers superior flexibility/durability compared to other high-performance jacket materials.



Abrasion Resistance	Good
Wear Resistance	Good
Flame Resistance	Excellent
Sunlight Resistance	Excellent
Flex Resistance	Excellent

Jacketing Options	
Weatherproof, halogen free, flame resistant, functional to 260°C	
0 Black	Fed-Std-595C #17038
1 Desert Tan	Fed-Std-595C #33446
2 Red	Fed-Std-595C #11120
3 Orange	Fed-Std-595C #12300
4 Yellow	Fed-Std-595C #13591
5 Green	Fed-Std-595C #14193
6 Blue	Fed-Std-595C #15125
7 Violet	Fed-Std-595C #17142
8 Gray	Fed-Std-595C #26270
9 White	Fed-Std-595C #17875
Consult factory for other specific Fed Std colors	

DURAELECTRIC™ ENVIRONMENTAL PERFORMANCE

Temperature rating: -60°C to 260°C
 Halogen free per IEC 60614-1
 Accelerated weathering and simulated solar radiation at ground level per IEC 60068-2-5; 56 Days exposure, suitable for greater than 50 years of service in direct sunlight
 Flame resistant per IEC 60614-1
 Flame resistant per UL 1685, section 12 (FT4/IEEE120), vertical-tray fire-propagation and smoke release test
 Flame resistant per FAR 25.853 (A) amendment 25-116, appendix F part I (A) (1) (i), 60 second vertical burn test
 Limiting oxygen index of 45 per ISO 4589-2:1999
 Low smoke per NES 711, smoke density of 11.75
 Smoke density class F1 per NF 16-101 IAW DIN EN 60695-2-11:2011
 Low smoke toxicity per NES 713, tested value of 1.9

Fungus rating of 0 per MIL-STD-810g method 508.5, Does not support fungal growth

ASTM D624, die B tear strength, 150 pounds per inch minimum on jacket material

Low outgassing per ASTM e595 after post curing, TML .06%, CVCM .006%, WVR .02%

Resistant to fluids per MIL-STD-810F, method 504

JP-8 per MIL-DTL-83133 (NATO type 34)

MIL-H-5606 hydraulic fluid

MIL-PRF-23699 lubricating oil

MIL-C-85570 cleaner

TT-I-735 Isopropyl alcohol

AMS 1432 potassium acetate

deicing/anti-icing fluid

MIL-C-87252 coolant

Amerex AFF fire extinguishing foam

961-001 TURBOFLEX, .125 WALL, 4500 VAC

961-001 Wire Weight and Outer Diameter			
AWG Code	Weight lbs/1000 ft. (nom.)	Ø A In. (mm)	Jacket wall thickness In. (mm)
G	494.50	.681 (17.30)	.125 (3.18)
H	600.00	.733 (18.62)	
I	749.50	.797 (20.24)	
J	916.00	.863 (21.92)	
K	1055.60	.913 (23.19)	
L	1806.20	1.140 (28.96)	

961-002 TURBOFLEX, .093 WALL, 3500 VAC

961-002 Wire Weight and Outer Diameter			
AWG Code	Weight lbs/1000 ft. (nom.)	Ø A In. (mm)	Jacket wall thickness In. (mm)
D	138.40	.386 (9.80)	.093 (2.36)
E	207.40	.457 (11.61)	
F	304.60	.528 (13.41)	
G	455.80	.617 (15.67)	
H	558.20	.649 (16.48)	
I	703.90	.733 (18.62)	
J	866.50	.799 (20.29)	
K	1003.10	.849 (21.56)	
L	1740.10	1.076 (27.33)	

961-003 TURBOFLEX, .062 WALL, 3000 VAC

961-003 Wire Weight and Outer Diameter			
AWG Code	Weight lbs/1000 ft. (nom.)	Ø A In. (mm)	Jacket wall thickness In. (mm)
A	40.20	.223 (5.66)	.062 (1.57)
B	56.20	.250 (6.35)	
C	81.00	.283 (7.19)	
D	117.90	.324 (8.23)	
E	182.80	.395 (10.03)	
F	275.90	.466 (11.84)	
G	422.00	.555 (14.10)	
H	521.40	.607 (15.42)	

961-004 TURBOFLEX, .032 WALL, 2000 VAC

961-004 Wire Weight and Outer Diameter			
AWG Code	Weight lbs/1000 ft. (nom.)	Ø A In. (mm)	Jacket wall thickness In. (mm)
R	14.40	.127 (3.23)	.032 (.81)
S	20.70	.144 (3.66)	
A	29.40	.163 (4.14)	
B	43.90	.190 (4.83)	
C	66.90	.223 (5.66)	
D	101.40	.264 (6.71)	
E	162.40	.335 (8.51)	
F	251.60	.406 (10.31)	
G	392.70	.495 (12.57)	



Rugged high-temperature, environmental Duralectric™ jacketing is available in a broad range of and colors including safety orange

Duralectric™ is the high-performance TurboFlex™ jacketing material perfectly suited for immersion, chemical or caustic fluid exposure, temperature extremes, UV radiation and more

Glenair *Duralectric*™ weatherproof jacketing is halogen free, flame resistant, and functional to 260°C. *Duralectric*™ far surpasses the accelerated solar weathering standards under IEC 60068-2-5, and is tested to 56 accelerated days, equivalent to 53 years of solar exposure. Glenair can supply the material in a variety of formats, including blown jacketing, as an extrusion over wire and cable, as an overmolding compound and as a self-vulcanizing repair tape.

Jacketing Options		
0	Black	Weatherproof, halogen free, flame resistant, functional to 260°C
1	Desert Tan	Fed Std #33446 Desert Tan color
2	Red	Pantone® 1797 U
3	Orange	OSHA Safety Orange to mark energized electrical cables
4	Yellow	Pantone® Yellow U
5	Green	Pantone® 355 U
6	Blue	Pantone® 3005 U
7	Violet	Fed Std 595; #37100
8	Gray	Qualified to US Navy MIL-PRF-24758A, Fed Std 595B #26270 Haze Gray color
9	White	Fed Std 595; #37875

Jacketing Material Properties	
Material Property	Duralectric™
Temperature Range	-60°C to +260°C
Specific Gravity	1.22
Weight: Lbs./Cubic Inch	.045
Abrasion Resistance	Good
Wear Resistance	Good
Flame Resistance	Excellent
Sunlight Resistance	Excellent

Chemical Resistance	
Aliphatic Hydrocarbons	Excellent
Aromatic Hydrocarbons	Excellent
Ketones, Etc.	Excellent
Oil & Gasoline	Excellent

Glenair Duralectric™ Material Specifications	
Temperature rating: -60°C to +260°C (with excursions to 290°C)	
Halogen free per IEC 60614-1. Less than 5mg of hcl per 1 gm of product tested.	
Accelerated Weathering (Solar) per IEC 60068-2-5; 56 days exposure	
Flame Resistant per IEC 60614-1; Material does not sustain combustion when the source of flame is removed.	
Low Smoke Index per NES 711 (11.75); Minimum standard is 25. The Glenair tested level is 11.75. This makes the material acceptable for interior applications as well as topside.	
Smoke Density Class F1 Per NF F 16-101 IAW DIN EN 60695-2-11:2001	
Toxicity Index per NES 713 (1.9); Minimum standard is 5. The Glenair tested level is 1.9. This makes the material acceptable for interior applications as well as topside.	
Colorable to Fed Std 595B	
Markable IAW MIL-PRF-24758A	
Oxygen Limiting Index = 45.1 Per EN ISO 4589-2:1999; Minimum is 28.	
ASTME E 595 vacuum outgassing—post bake results: TML .06%, CVCM .006%, WVR .02%	
Fungus resistance testing (rating of 0) per MIL-STD-810F, method 508.5	
ASTM D624 DIE B tear test: 150 KN/M	
12 Sec Vertical Burn: (Pass) Per 14CFR Part 25.853(a) amdt 25-116 App F Part 1 (a)(1)(ii)	
Fluids Per MIL STD 810F, Method 504	Cleaner (MIL-C-85570): CALLA-855
Fuel (MIL-T-83133): JPG	Solvent (Isopropyl Alcohol): TT-I-735
Fuel (MIL-T-83133): JPG	De Icer (AMS-1432): E36 Runway Deicer
Hydraulic Fluid (MIL H 5606): ROYCO 756	Coolant (MIL-C-87252): Coolanol 25R
Lube Oil (MIL-L-23699): ROYCO-500	Fire Extinguishant Foam: AMEREX AFFF



Series 970 PowerTrip™ Connectors for use with TurboFlex™ Cable



Lightweight plug with ratcheting coupling nut and LouverBand contacts



Keyed receptacle with superior sealing and EMI shielding

- Fast, easy mating with triple-start ACME thread: 360° turn for full mating
- Reduced size and weight compared to MIL-DTL-5015
- LouverBand sockets for improved current ratings and longer life
- Splined backshell interface for improved backshell attachment and EMI shielding
- Ratcheting coupling nut for secure mating
- Operating temperature -65° C to +200° C

PowerTrip™ and TurboFlex™—The ultimate rugged-environment power transmission solution



MIL-DTL-5015 contact arrangements



MIL-DTL-38999 triple-start coupling



MIL-DTL-28840 splined backshell interface



Series 970 PowerTrip™

Series 970 PowerTrip™ Connector Styles



Plug
970-001



Square Flange Receptacles
970-003



Jam Nut Receptacles
970-004



Cable Receptacles
970-005



Feed-Thru Bulkhead
970-006



Hermetic Feed-Thru Bulkhead
970-007

Plug

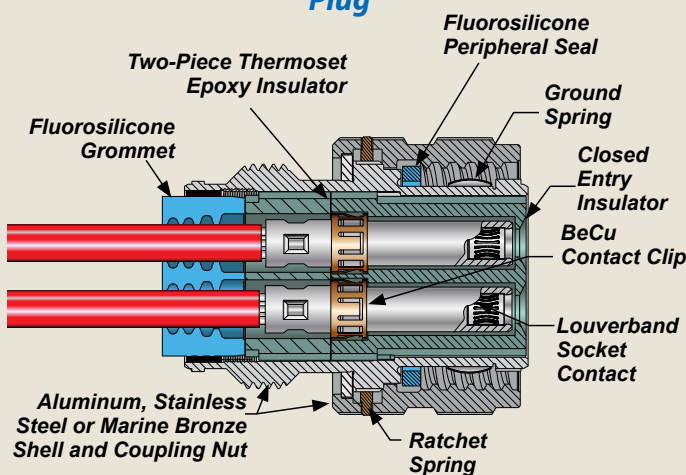

Receptacle

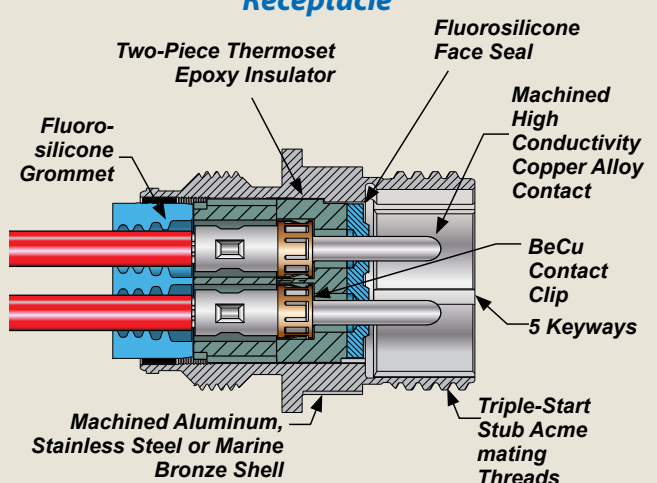

Series 970 PowerTrip™ Connectors for use with TurboFlex™ Cable



Lower contact resistance of LouverBand vs. conventional split-tine contacts

Contact Resistance after 1000 Mating Cycles

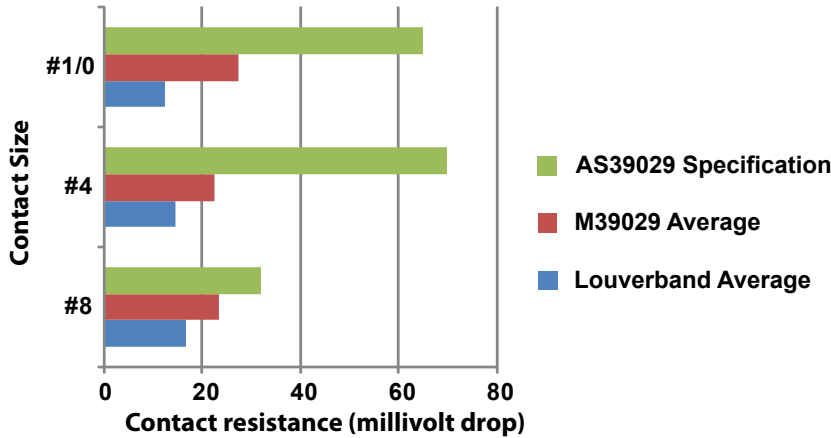

LouverBand Spring

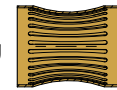

Split-tine contact on the left,
LouverBand contact on the right

PowerTrip™ Materials	
Shells, Jam Nuts	Aluminum alloy, stainless steel or marine bronze
Contacts	High conductivity copper alloy, gold or silver-plated
Insulators	Glass-reinforced epoxy
Contact Retention Clip	Copper alloy
Seal, O-rings, Grommet	Fluorosilicone rubber
Spring	Nickel-plated copper alloy



Heavy-duty PowerTrip™ backshells may be ordered by using the "P" connector designator in any standard backshell series part number

Series 970 PowerTrip™ Specifications	
Current Rating	Up to 225 A.
Dielectric Withstanding Voltage	2000 VAC
Insulation Resistance	5000 megohms minimum
Operating Temperature	-65° C. to +200° C.
Shock	300 g.
Vibration	37 g.
Shielding Effectiveness	65 dB minimum from 1GHz to 10GHz.
Durability	2000 mating cycles

Series 970 Contact Arrangements						
Principal Contact Size	Contact Arrangement	Contact Size and Qty				
		#16	#12	#8	#4	#1/0
Size #8	18-2			2		
	18-4		2	2		
	20-3			3		
	20-5		2	3		
	20-7	4		3		
	20-4			4		
	24-5			5		
Size #4	24-2				2	
	24-6		4		2	
	24-3				3	
	24-A6		3		3	
	28-4				4	
	28-9	5			4	
	32-5				5	
Size #1/0	32-2					2
	32-4				2	2
	32-3					3
	32-6		3			3
	36-4					4
	40-5					5



961-001
TurboFlex Power Cable with .125" Duraelectric™ Jacket
4,500 VAC

961-001 FOR USE WITH A VARIETY OF POWER CONNECTOR SERIES

How To Order

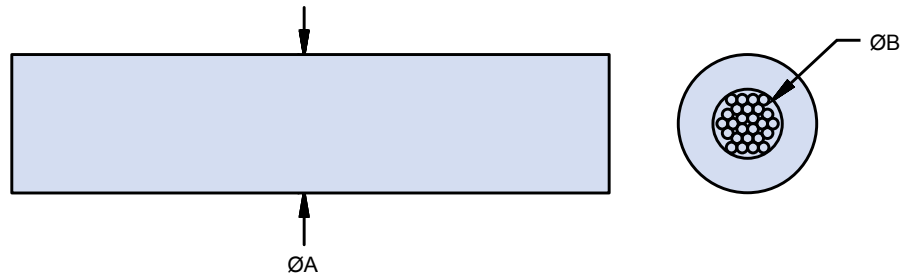
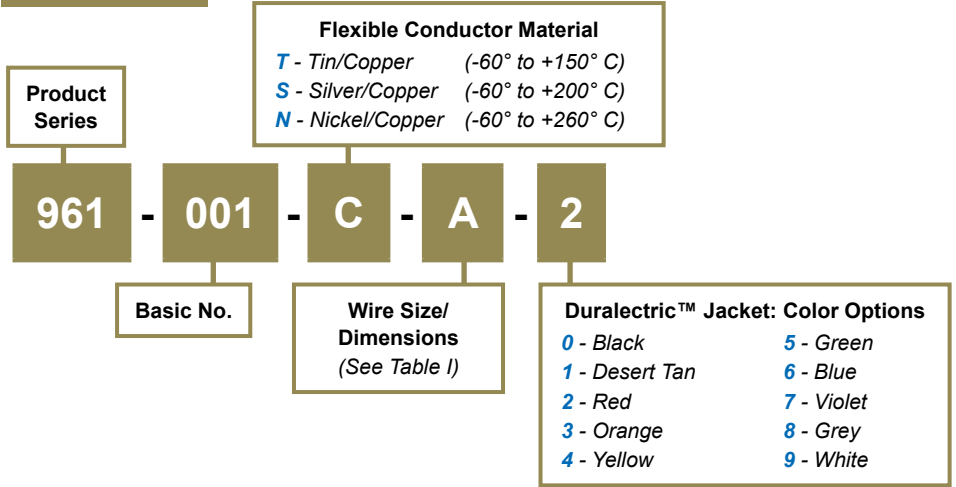

E

Table I TurboFlex .125 Jacket Wall: Wire Size and Dimensions

AWG Code	AWG	Strand / Count / AWG	Cir Mil (nom)	Weight lbs/1000 ft. (nom.)	Ø A in. (mm)	Ø B in. (mm)	DC Resistance @ 20°C (Ohms / 1000 ft.)			Ampacity (Amps) 40°C Ambient	
							Nickel Copper	Tin Copper	Silver Copper	Nickel Copper	Tin/Silver Copper
G	1/0	7 X 7 X 86/36	105350	494.50	.681 (17.30)	.431 (10.95)	.1178	.1188	.1107	532	399
H	2/0	7 X 7 X 108/36	132300	600.00	.733 (18.62)	.483 (12.27)	.0938	.0946	.0882	591	467
I	3/0	19 X 7 X 51/36	169575	749.50	.797 (20.24)	.547 (13.89)	.0738	.0745	.0694	708	546
J	4/0	19 X 7 X 64/36	212800	916.00	.863 (21.92)	.613 (15.57)	.0588	.0594	.0553	830	629
K	250 MCM	19 X 7 X 75/36	249375	1055.60	.913 (23.19)	.663 (16.84)	.0479	.0483	.0450	910	705
L	450 MCM	19 X 7 X 135/36	448875	1806.20	1.140 (28.96)	.890 (22.61)	.0266	.0263	.0250	1320	1020

*Consult factory for correction factors for ambient temperatures other than 40°C (104°F)

Notes

1. Consult factory for other federal standard color options.
3. Bend radius is 3x the outer diameter
4. Cable shall be marked with "Glenair TurboFlex," wire gauge, FR and voltage rating.

961-002
TurboFlex Power Cable with .093" Duraelectric™ Jacket
3,500 VAC



961-002 FOR USE WITH A VARIETY OF POWER CONNECTOR SERIES

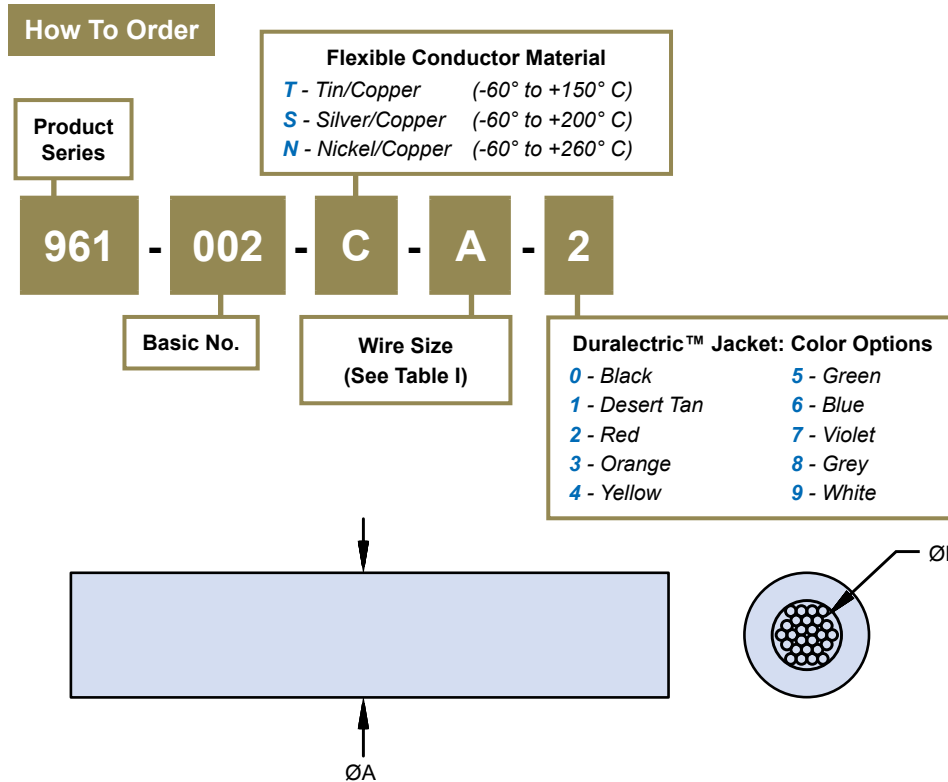

Table I TurboFlex .093 Jacket Wall: Wire Size and Dimensions

AWG Code	AWG	Strand / Count / AWG	Cir Mil (nom)	Weight lbs/1000 ft. (nom.)	Ø A in. (mm)	Ø B in. (mm)	DC Resistance @ 20°C (Ohms / 1000 ft.)			Ampacity (Amps) 40°C Ambient	
							Nickel Copper	Tin Copper	Silver Copper	Nickel Copper	Tin/Silver Copper
D	6	7 x 150/36	26250	138.40	.386 (9.80)	.200 (5.08)	.4551	.4593	.4278	205	165
E	4	7 x 7 x 34/36	41650	207.40	.457 (11.61)	.271 (6.88)	.2979	.3006	.2800	278	220
F	2	7 x 7 x 54/36	66150	304.60	.528 (13.41)	.342 (8.69)	.1876	.1893	.1763	381	293
G	1/0	7 X 7 X 86/36	105350	494.50	.617 (15.67)	.431 (10.95)	.1178	.1188	.1107	532	399
H	2/0	7 X 7 X 108/36	132300	600.00	.649 (16.48)	.483 (12.27)	.0938	.0946	.0882	591	467
I	3/0	19 X 7 X 51/36	169575	749.50	.733 (18.62)	.547 (13.89)	.0738	.0745	.0694	708	546
J	4/0	19 X 7 X 64/36	212800	916.00	.799 (20.29)	.613 (15.57)	.0588	.0594	.0553	830	629
K	250 MCM	19 X 7 X 75/36	249375	1055.60	.849 (21.56)	.663 (16.84)	.0479	.0483	.0450	910	705
L	450 MCM	19 X 7 X 135/36	448875	1806.20	1.076 (27.33)	.890 (22.61)	.0266	.0263	.0250	1320	1020

*Consult factory for correction factors for ambient temperatures other than 40°C (104°F)

Notes

1. Consult factory for other federal standard color options.
3. Bend radius is 3x the outer diameter
4. Cable shall be marked with "Glenair TurboFlex," wire gauge, FR and voltage rating.



961-003

**TurboFlex Power Cable with .062" Duraelectric™ Jacket
3,000 VAC**
961-003 FOR USE WITH A VARIETY OF POWER CONNECTOR SERIES
How To Order
Product Series

961

- 003 -

C -

A -

2

Basic No.

**Wire Size
(See Table I)**
Flexible Conductor Material

T - Tin/Copper (-60° to +150° C)
S - Silver/Copper (-60° to +200° C)
N - Nickel/Copper (-60° to +260° C)

Duraelectric™ Jacket: Color Options

0 - Black 5 - Green
 1 - Desert Tan 6 - Blue
 2 - Red 7 - Violet
 3 - Orange 8 - Grey
 4 - Yellow 9 - White

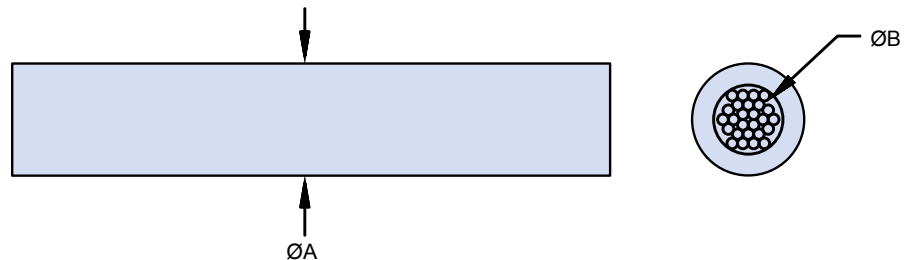
Table I TurboFlex .062 Jacket Wall: Wire Size and Dimensions

AWG Code	AWG	Strand / Count / AWG	Cir Mil (nom)	Weight lbs/1000 ft. (nom.)	Ø A in. (mm)	Ø B in. (mm)	DC Resistance @ 20°C (Ohms / 1000 ft.)			Ampacity (Amps) 40°C Ambient	
							Nickel Copper	Tin Copper	Silver Copper	Nickel Copper	Tin/Silver Copper
A	12	7 X 37/36	6475	40.20	.223 (5.66)	.099 (2.51)	1.8450	1.8620	1.7340	78	68
B	10	7 X 59/36	10325	56.20	.250 (6.35)	.126 (3.20)	1.1570	1.1680	1.0880	107	90
C	8	7 X 95/36	16625	81.00	.283 (7.19)	.159 (4.04)	.7188	.7252	.6755	142	124
D	6	7 x 150/36	26250	138.40	.386 (9.80)	.200 (5.08)	.4551	.4593	.4278	205	165
E	4	7 x 7 x 34/36	41650	207.40	.457 (11.61)	.271 (6.88)	.2979	.3006	.2800	278	220
F	2	7 x 7 x 54/36	66150	304.60	.528 (13.41)	.342 (8.69)	.1876	.1893	.1763	381	293
G	1/0	7 X 7 X 86/36	105350	494.50	.617 (15.67)	.431 (10.95)	.1178	.1188	.1107	532	399
H	2/0	7 X 7 X 108/36	132300	600.00	.649 (16.48)	.483 (12.27)	.0938	.0946	.0882	591	467

*Consult factory for correction factors for ambient temperatures other than 40°C (104°F)

Notes

1. Consult factory for other federal standard color options.
3. Bend radius is 3x the outer diameter
4. Cable shall be marked with "Glenair TurboFlex," wire gauge, FR and voltage rating.

961-004 TurboFlex Power Cable with .032" Duralectric™ Jacket 2,000 VAC



961-004 FOR USE WITH SERIES 970 POWERTRIP™ CONNECTORS AND LOUVERBAND CONTACTS AND/OR OTHER POWER CONNECTOR SERIES

Compatible Contacts	
AWG	Contact P/N
20	850-037-16 Pin
	850-038-16 Socket
16	850-037-16 Pin
	850-038-16 Socket
14	850-037-12 Pin
	850-038-12 Socket
12	850-037-12 Pin
	850-038-12 Socket
10	850-026-8-10-X Pin
	850-027-8-10-X Socket
8	850-026-8-8-X Pin
	850-027-8-8-X Socket
6	850-026-4-6-X Pin
	850-027-4-6-X Socket
4	850-026-4-4-X Pin
	850-027-4-4-X Socket
2	850-026-0-2-X Pin
	850-027-0-2-X Socket
1/0	850-026-0-0-X Pin
	850-027-0-0-X Socket

How To Order

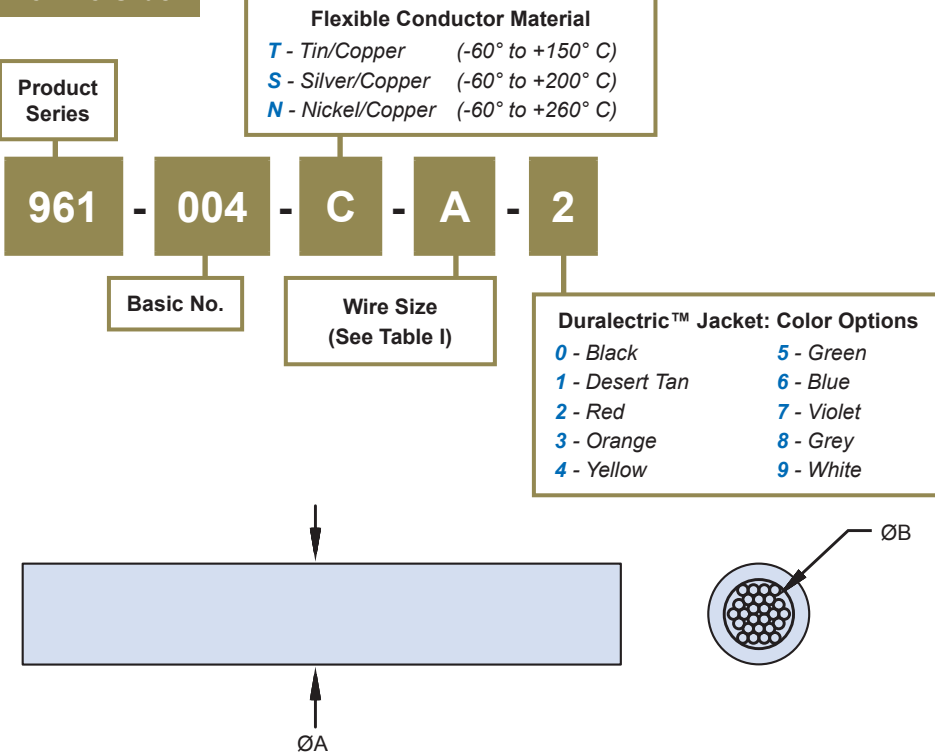

Table I TurboFlex .032 Jacket Wall: Wire Size and Dimensions

16 AWG up to I/O Code	AWG	Strand / Count / AWG	Cir Mil (nom)	Weight lbs/1000 ft. (nom.)	Ø A in. (mm)	Ø B in. (mm)	DC Resistance @ 20°C (Ohms / 1000 ft.)			Ampacity (Amps) 40°C Ambient	
							Nickel Copper	Tin Copper	Silver Copper	Nickel Copper	Tin/Silver Copper
T	20	42/36	1050	7.60	.101 (2.6)	.037 (0.9)	10.7178	10.7538	10.0747	16	14
R	16	7 X 15/36	2625	14.40	.127 (3.2)	.063 (1.6)	4.5510	4.5930	4.2780	40	36
S	14	7 X 24/36	4200	20.70	.144 (3.7)	.080 (2.0)	2.8450	2.8710	2.6470	59	54
A	12	7 X 37/36	6475	29.40	.163 (4.14)	.099 (2.51)	1.8450	1.8620	1.7340	78	68
B	10	7 X 59/36	10325	43.90	.190 (4.83)	.126 (3.20)	1.1570	1.1680	1.0880	107	90
C	8	7 X 95/36	16625	66.90	.223 (5.66)	.159 (4.04)	.7188	.7252	.6755	142	124
D	6	7 X 150/36	26250	101.40	.264 (6.7)	.200 (5.08)	.4551	.4593	.4278	205	165
E	4	7 X 7 X 34/36	41650	162.40	.335 (8.5)	.271 (6.88)	.2979	.3006	.2800	278	220
F	2	7 X 7 X 54/36	66150	251.60	.406 (10.3)	.342 (8.7)	.1876	.1893	.1763	381	293
G	1/0	7 X 7 X 86/36	105350	392.70	.495 (12.6)	.431 (10.9)	.1178	.1188	.1107	532	399

*Consult factory for correction factors for ambient temperatures other than 40°C (104°F)

Notes

1. Consult factory for other federal standard color options.
3. Bend radius is 3x the outer diameter
4. Cable shall be marked with "Glenair TurboFlex," wire gauge, FR and voltage rating.

SERIES 964

OPTICAL FIBER CABLE

No Minimums
No Minimums
on Quantity
Minimum orders

Singlemode and multimode graded index fiber optic cable for mission-critical applications



Well designed fiber optic connection systems begin with high-reliability single and multimode cable. Glenair is able to fabricate and supply a targeted range of fiber media—all available without expensive minimum length requirements. The goal of our fiber media shop is to provide a fast-turn supply of specialty F/O media for use in our own cable assemblies, customer prototype projects and other short-run, limited bulk length applications. Nobody can beat Glenair when it comes to providing fiber optic media with rugged and yet flexible media protection. We are absolute experts in this field and can suggest and supply everything from jacketed cable resistant to fuel exposure to crush-proof polymer-core conduit solutions. And because we make and stock all the component parts ourselves, we can offer lightning-fast turnaround on even highly specialized requirements.



Glenair, Inc.
1211 Air Way
Glendale, CA
91201-2497
818-247-6000
sales@glenair.com
www.glenair.com

Compatible Fiber Optic Termini

M29504 type for D38999 Series III type connectors	Glenair High Density (GHD)	M29504 QPL for MIL-PRF-28876 connectors	Mighty Mouse #16, #20HD, #23

Optical Fiber Cables Selection Guide



964-002

9.3/125 Singlemode graded index fiber optic cable with Hytrel jacket

F-6



964-007

9.3/125 Singlemode graded index fiber optic cable with ETFE jacket

F-7



964-003

50/125 Multimode graded index fiber optic cable with Hytrel jacket

F-8



964-008

50/125 Multimode graded index fiber optic cable with ETFE jacket

F-9



964-004

62.5/125 Multimode graded index fiber optic cable with Hytrel jacket

F-10



964-005

62.5/125 Multimode graded index fiber optic cable

F-11



964-006

100/140 Multimode graded index fiber optic cable with Hytrel jacket

F-12



964-009

100/140 Multimode graded index fiber optic cable with ETFE jacket

F-13



SERIES 050 Harsh-Environment

Opto-Electronic Interconnect Solutions

Opto-electronic media converters and active components for Ethernet, high-speed digital data, video media, and signal aggregation

- Significant performance advantages over electrical copper including expanded bandwidth, reduced size and weight, increased distance, and improved electromagnetic compatibility
- Take advantage of fiber optic virtues, while reducing complexity and maintenance of fiber optic systems
- Size #8 Opto-Electronic contacts for singlemode and multimode optical fiber

SIZE #8 CAVITY OPTO-ELECTRONIC CONTACTS AND ACTIVE CONNECTORS

- Fast and Gigabit Ethernet, DVI, HDMI capable transmitter and receiver-equipped contacts
- ARINC 664, 801, 803, 804 and 818 standard compliant
- Link distances up to 550 meters, multimode
- Single, 3.3 V power supply
- Wave-solderable termination with RoHS-compliant solders



Mighty Mouse receptacle incorporating size #8 opto-electronic contacts

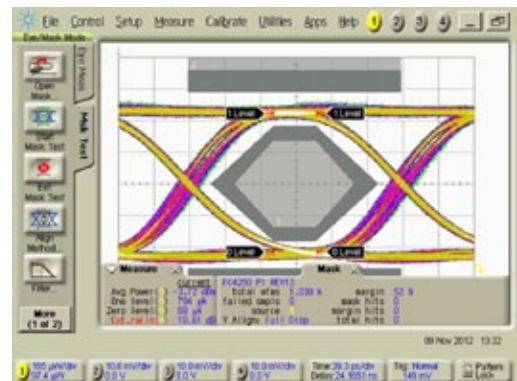

SERIES 050 Harsh-Environment Opto-Electronic Interconnect Solutions

ENVIRONMENTAL OPTO-ELECTRONIC SOLUTIONS

- Ethernet media converters 10/100/1000 and 10G
- Video media converters DVI, SDI, ARINC 818
- High-Speed digital data to 12.5 GB/sec
- Signal aggregation media converters
- Custom solutions with ruggedized, ultraminiature packaging to suit any application



MEDIA CONVERTER



- 10/100/1000BASE-T to 1000BASE-SX/LX10 media converter
- IEEE 802-3-2005 Gigabit Ethernet standard compliant
- Up to 550 meters, multimode
- Up to 10 kilometers, singlemode

Table I: Signal Protocol		
Code	Name	Medium
SX	1000BASE-SX	Multimode Fiber
LX10	1000BASE-LX	Singlemode Fiber

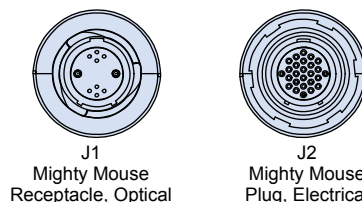

SEVEN PORT UNMANAGED ETHERNET SWITCH



- Seven copper (10/100/1000 Mbps) Ethernet ports IAW IEEE 802.3:2005
- Cable distances up to 100 meters
- Unmanaged Ethernet switch, no configuration required
- Non-blocking switch fabric allows 1000 Mbps data rate on all seven ports simultaneously

ACTIVE/OPTICAL CABLE WITH MEDIA CONVERTER

- 10/100/1000BASE-T to 1000BASE-SX/LX10 active cable
- IEEE 802.3:2005 Gigabit Ethernet standard compliant
- Up to 550 meters, multimode
- Up to 10 kilometers, singlemode

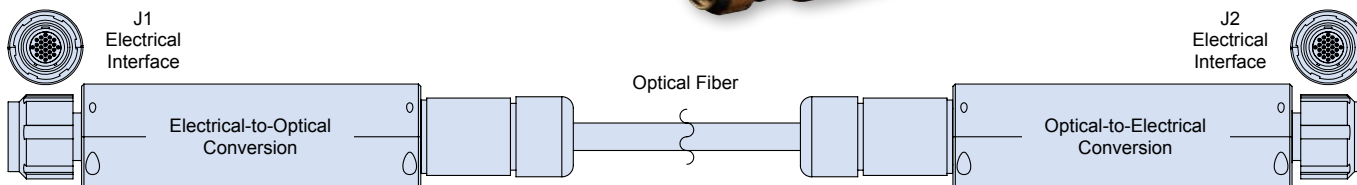
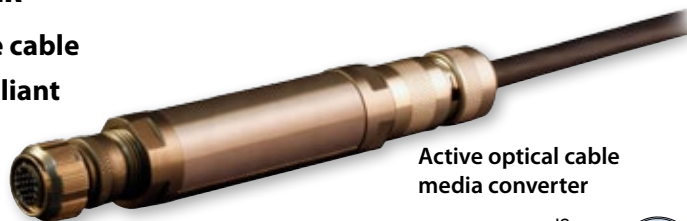

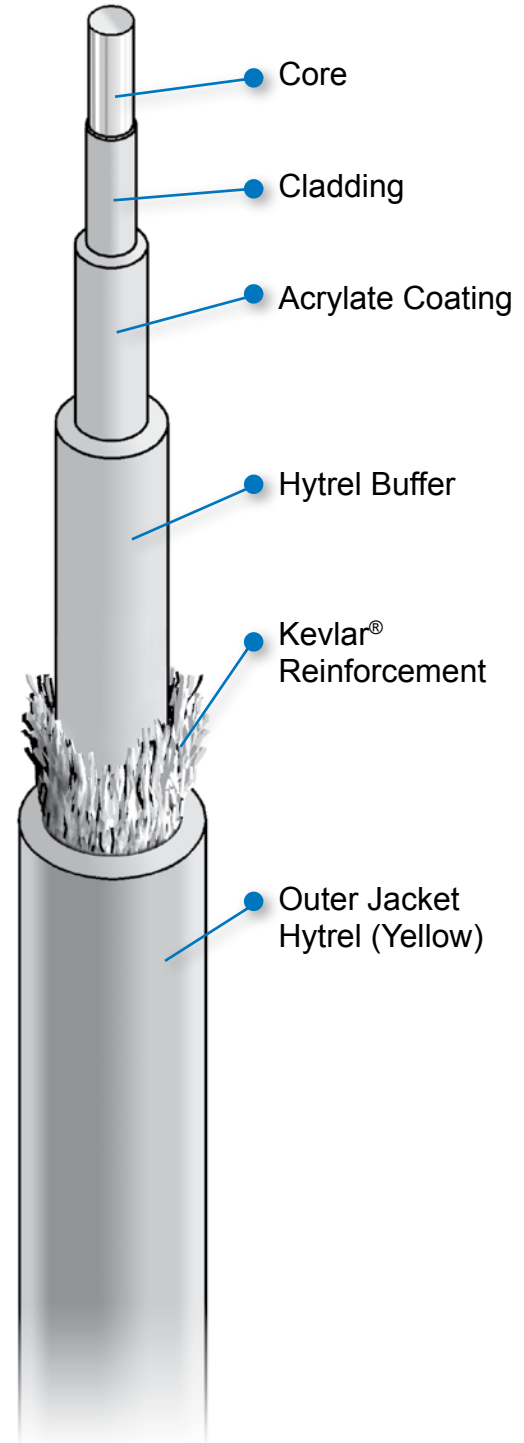
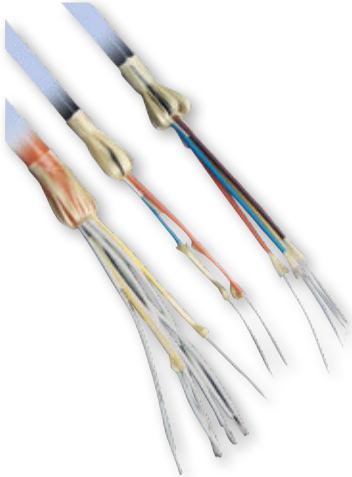
9.3/125 SINGLEMODE GRADED INDEX FIBER OPTIC CABLE WITH HYTREL JACKET

Cable Specifications	
Core/Mode Field Diameter	9.3 $\mu\text{m} \pm 3 \mu\text{m}$
Cladding Diameter	125 $\mu\text{m} \pm 2 \mu\text{m}$
Primary Buffer	500 $\mu\text{m} \pm 25 \mu\text{m}$
Secondary Buffer	900 $\mu\text{m} \pm 50 \mu\text{m}$
Jacket	.083 + .007 Inch Diameter
Attenuation:	
@ 1310 nm	3.0 dB/km
@ 1550 nm	2.0 dB/km
Numerical Aperture	.110 + .020
Index Profile	Stepped
Proof Test	>100 KPSI
Operating Temperature	-40° C to 85° C

Consult Factory for price in feet or meters and for
Standard Length Tolerance

Kevlar® is a registered trademark of DuPont Company.

964-007
Bulk Simplex Fiber Optic Cable
9.3/125 Singlemode Stepped Index (ETFE Jacket)



9.3/125 SINGLEMODE GRADED INDEX FIBER OPTIC CABLE WITH ETFE JACKET

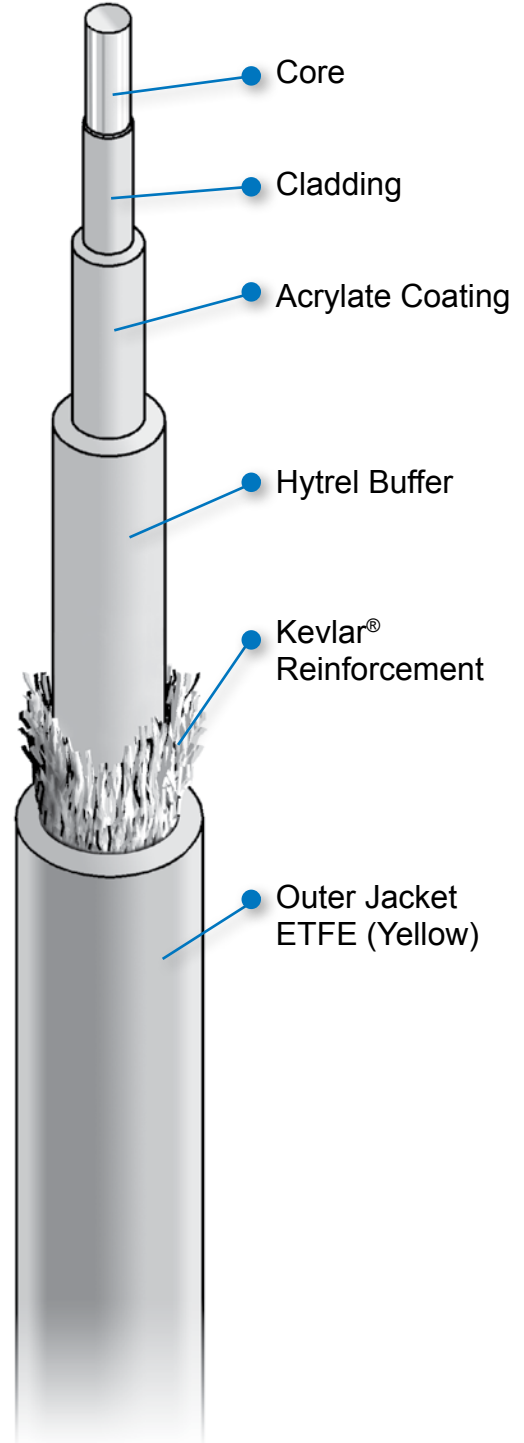
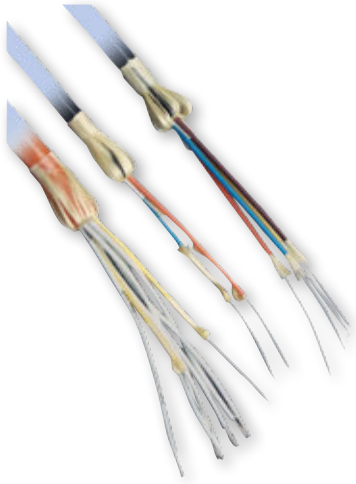

Cable Specifications	
Core/Mode Field Diameter	9.3 $\mu\text{m} \pm 3 \mu\text{m}$
Cladding Diameter	125 $\mu\text{m} \pm 2 \mu\text{m}$
Primary Buffer	500 $\mu\text{m} \pm 25 \mu\text{m}$
Secondary Buffer	900 $\mu\text{m} \pm 50 \mu\text{m}$
Jacket	.083 + .007 Inch Diameter
Attenuation:	
@ 1310 nm	3.0 dB/km
@ 1550 nm	2.0 dB/km
Numerical Aperture	.110 + .020
Index Profile	Stepped
Proof Test	>100 KPSI
Operating Temperature	-40° C to 85° C

Consult Factory for price in feet or meters and for Standard Length Tolerance

Kevlar® is a registered trademark of DuPont Company.



50/125 MULTIMODE GRADED INDEX FIBER OPTIC CABLE WITH HYTREL JACKET

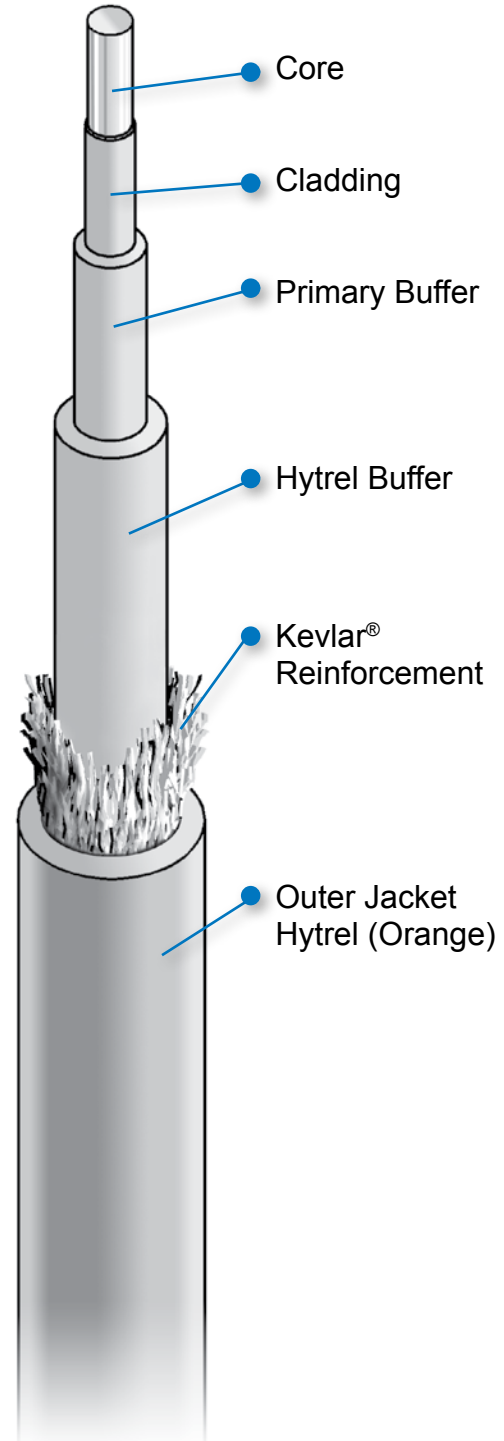
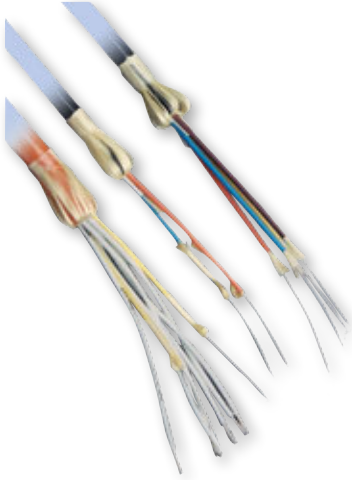

Cable Specifications	
Core/Mode Field Diameter	50 $\mu\text{m} \pm 3 \mu\text{m}$
Cladding Diameter	125 $\mu\text{m} \pm 3 \mu\text{m}$
Primary Buffer	500 $\mu\text{m} \pm 25 \mu\text{m}$
Secondary Buffer	900 $\mu\text{m} \pm 50 \mu\text{m}$
Jacket	.083 + .007 Inch Diameter
Attenuation: @ 850 nm @ 1300 nm	4.0 dB/km 2.5 dB/km
Bandwidth: @ 850 nm @ 1300 nm	400 Mhz/km Minimum 400 Mhz/km Minimum
Numerical Aperture	.200 Nominal
Index Profile	Graded
Proof Test	100 KPSI
Operating Temperature	-40° C to 85° C

Consult Factory for price in feet or meters and for
Standard Length Tolerance

Glenair also carries 62.5 and 50 μm Multimode fiber that meet FAR25 flammability requirements. Consult factory for more information.

Kevlar® is a registered trademark of DuPont Company.

964-008
Bulk Simplex Fiber Optic Cable
50/125 Graded Index (ETFE Jacket)



50/125 MULTIMODE GRADED INDEX FIBER OPTIC CABLE WITH ETFE JACKET

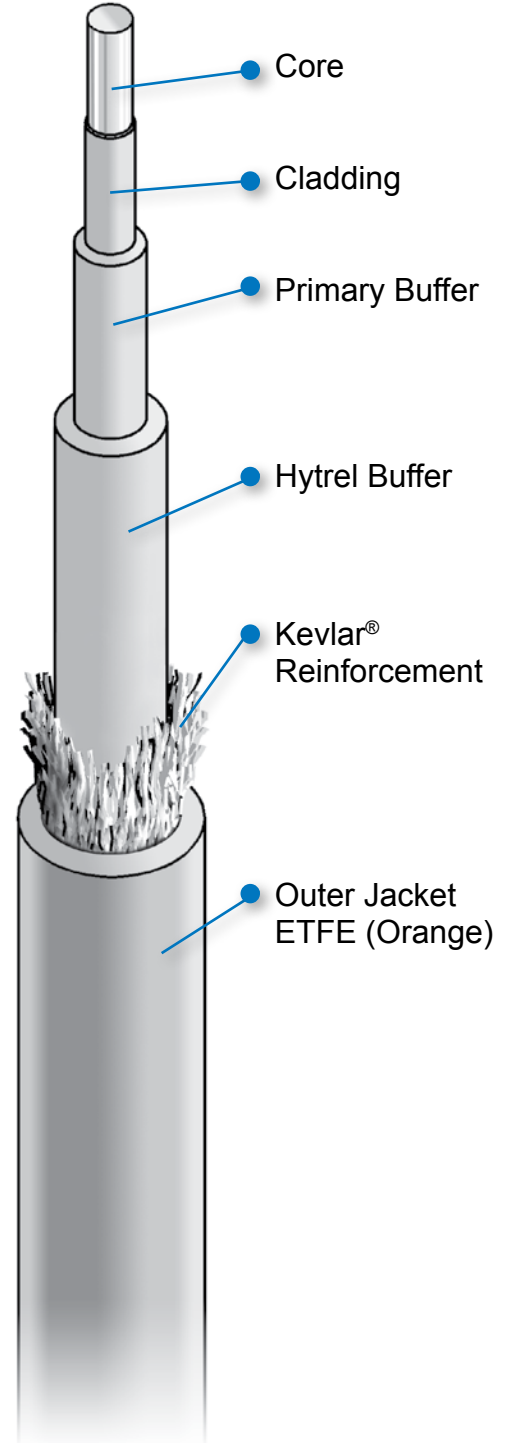
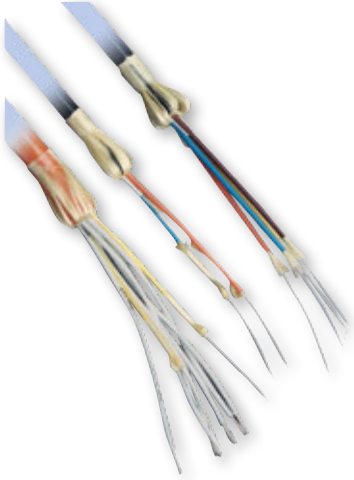

Cable Specifications	
Core/Mode Field Diameter	50 $\mu\text{m} \pm 3 \mu\text{m}$
Cladding Diameter	125 $\mu\text{m} \pm 3 \mu\text{m}$
Primary Buffer	500 $\mu\text{m} \pm 25 \mu\text{m}$
Secondary Buffer	900 $\mu\text{m} \pm 50 \mu\text{m}$
Jacket	.083 + .007 Inch Diameter
Attenuation:	
@ 850 nm	4.0 dB/km
@ 1300 nm	2.5 dB/km
Bandwidth:	
@ 850 nm	400 Mhz/km Minimum
@ 1300 nm	400 Mhz/km Minimum
Numerical Aperture	.200 Nominal
Index Profile	Graded
Proof Test	100 KPSI
Operating Temperature	-40° C to 85° C

Consult Factory for price in feet or meters and for Standard Length Tolerance

Glenair also carries 62.5 and 50 μm Multimode fiber that meet FAR25 flammability requirements. Consult factory for more information.

Kevlar® is a registered trademark of DuPont Company.

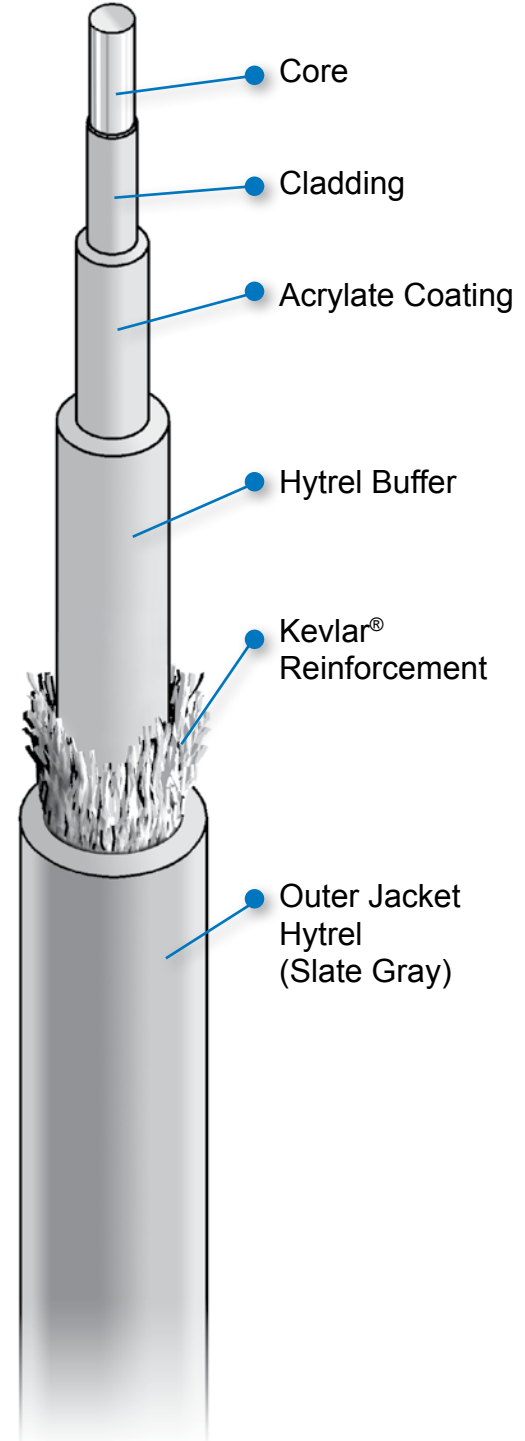
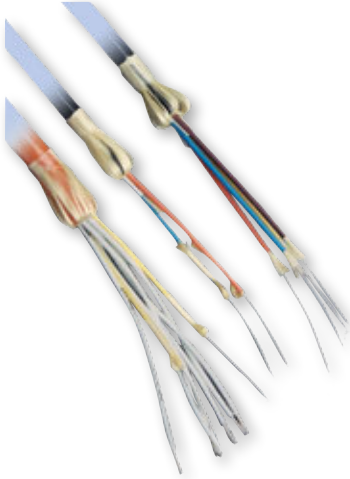

62.5/125 MULTIMODE GRADED INDEX FIBER OPTIC CABLE WITH HYTREL JACKET

Cable Specifications	
Core/Mode Field Diameter	62.5 $\mu\text{m} \pm 3 \mu\text{m}$
Cladding Diameter	125 $\mu\text{m} \pm 3 \mu\text{m}$
Primary Buffer	500 $\mu\text{m} \pm 25 \mu\text{m}$
Secondary Buffer	900 $\mu\text{m} \pm 50 \mu\text{m}$
Jacket	.083 + .007 Inch Diameter
Attenuation:	
@ 850 nm	4.0 dB/km
@ 1300 nm	2.0 dB/km
Bandwidth:	
@ 850 nm	160 Mhz/km Minimum
@ 1300 nm	500 Mhz/km Minimum
Numerical Aperture	0.275 Nominal
Index Profile	Graded
Proof Test	>100 KPSI
Operating Temperature	-40° C to 85° C

**Consult Factory for price in feet or meters and for
Standard Length Tolerance**

Glenair also carries 62.5 and 50 μm Multimode fiber that meet FAR25 flammability requirements. Consult factory for more information.

Kevlar® is a registered trademark of DuPont Company.

964-005
Bulk Simplex Fiber Optic Cable
62.5/125 Graded Index (ETFE Jacket)



62.5/125 MULTIMODE GRADED INDEX FIBER OPTIC CABLE

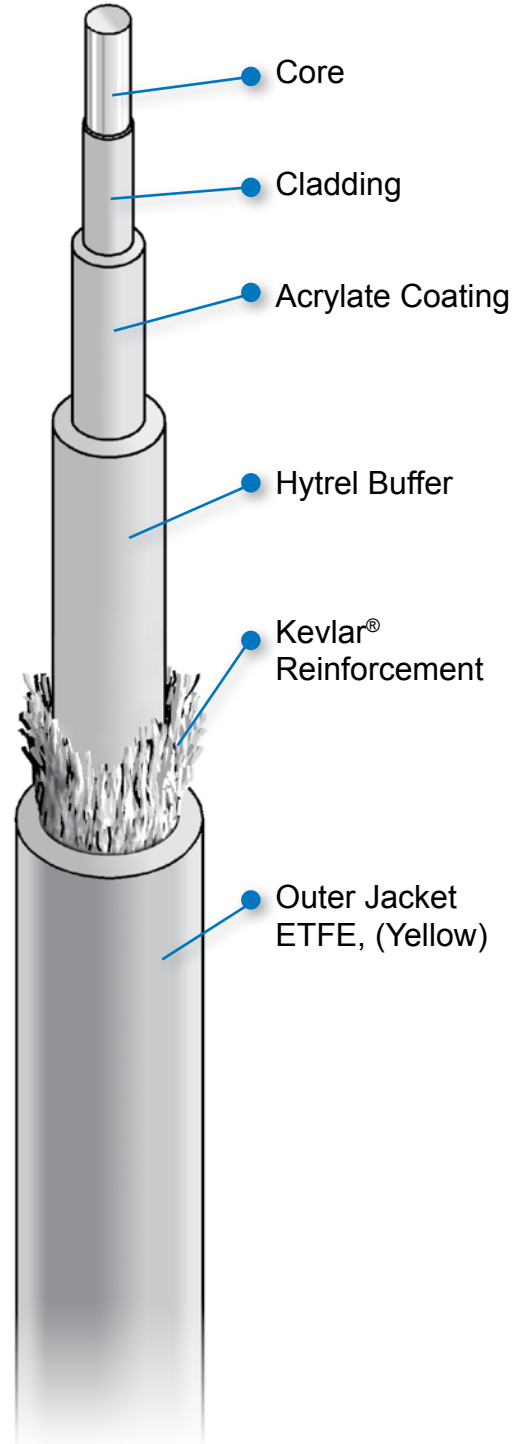
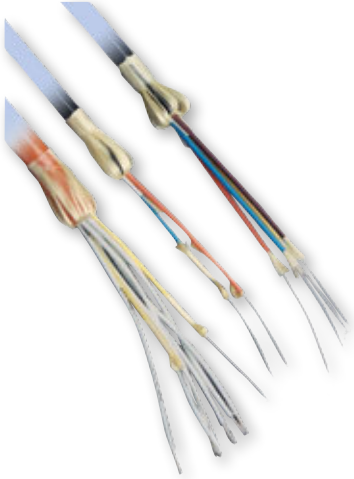

Cable Specifications	
Core/Mode Field Diameter	62.5 $\mu\text{m} \pm 3 \mu\text{m}$
Cladding Diameter	125 $\mu\text{m} \pm 3 \mu\text{m}$
Primary Buffer	500 $\mu\text{m} \pm 25 \mu\text{m}$
Secondary Buffer	900 $\mu\text{m} \pm 50 \mu\text{m}$
Jacket	.083 + .007 Inch Diameter
Attenuation:	
@ 850 nm	4.0 dB/km
@ 1300 nm	2.0 dB/km
Bandwidth:	
@ 850 nm	160 Mhz/km Minimum
@ 1300 nm	500 Mhz/km Minimum
Numerical Aperture	0.275 Nominal
Index Profile	Graded
Proof Test	>100 KPSI
Operating Temperature	-40° C to 85° C
Core Noncircularity	< 5%
Cladding Noncircularity	< 2%

Consult Factory for price in feet or meters and for Standard Length Tolerance

Glenair also carries 62.5 and 50 μm Multimode fiber that meet FAR25 flammability requirements. Consult factory for more information.

Kevlar® is a registered trademark of DuPont Company.

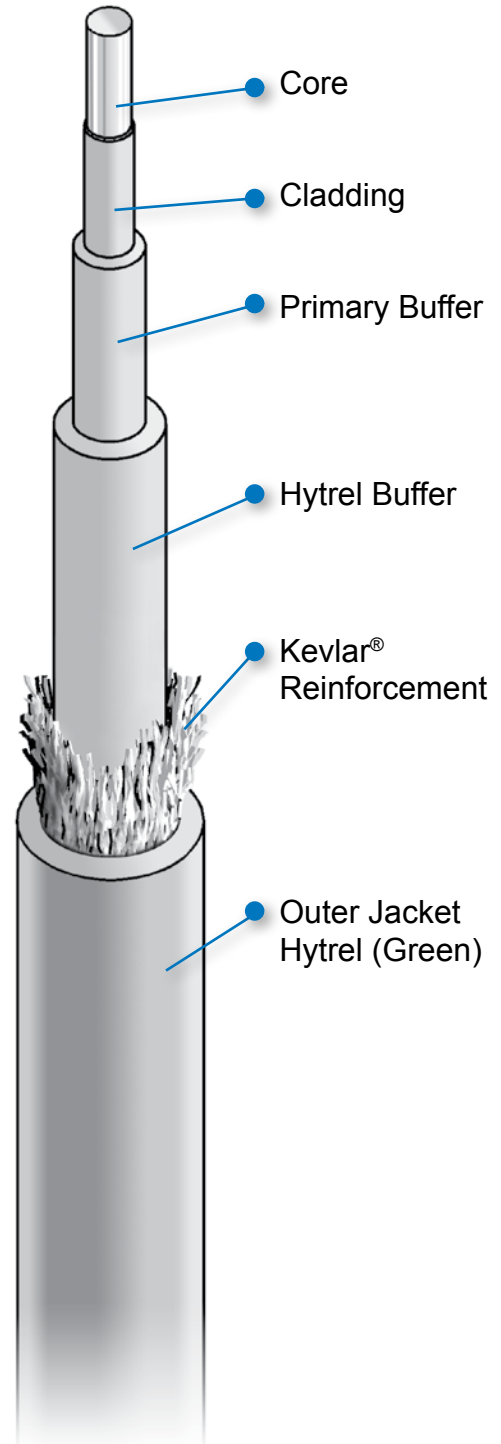
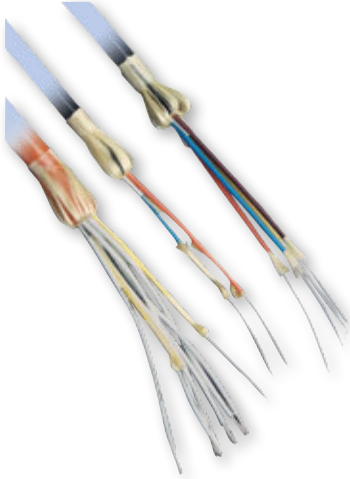

100/140 MULTIMODE GRADED INDEX FIBER OPTIC CABLE WITH HYTREL JACKET

Cable Specifications	
Core/Mode Field Diameter	100 $\mu\text{m} \pm 4 \mu\text{m}$
Cladding Diameter	140 $\mu\text{m} \pm 3 \mu\text{m}$
Primary Buffer	500 $\mu\text{m} \pm 25 \mu\text{m}$
Secondary Buffer	900 $\mu\text{m} \pm 50 \mu\text{m}$
Jacket	.083 + .007 Inch Diameter
Attenuation:	
@ 850 nm	6.0 dB/km
@ 1300 nm	4.0 dB/km
Bandwidth:	
@ 850 nm	100 Mhz/km Minimum
@ 1300 nm	100 Mhz/km Minimum
Numerical Aperture	.290 + .015
Index Profile	Graded
Proof Test	>100 KPSI
Operating Temperature	-40° C to 85° C

Consult Factory for price in feet or meters and for
Standard Length Tolerance

Kevlar[®] is a registered trademark of DuPont Company.

964-009
Bulk Simplex Fiber Optic Cable
100/140 Graded Index (ETFE Jacket)



100/140 MULTIMODE GRADED INDEX FIBER OPTIC CABLE WITH ETFE JACKET

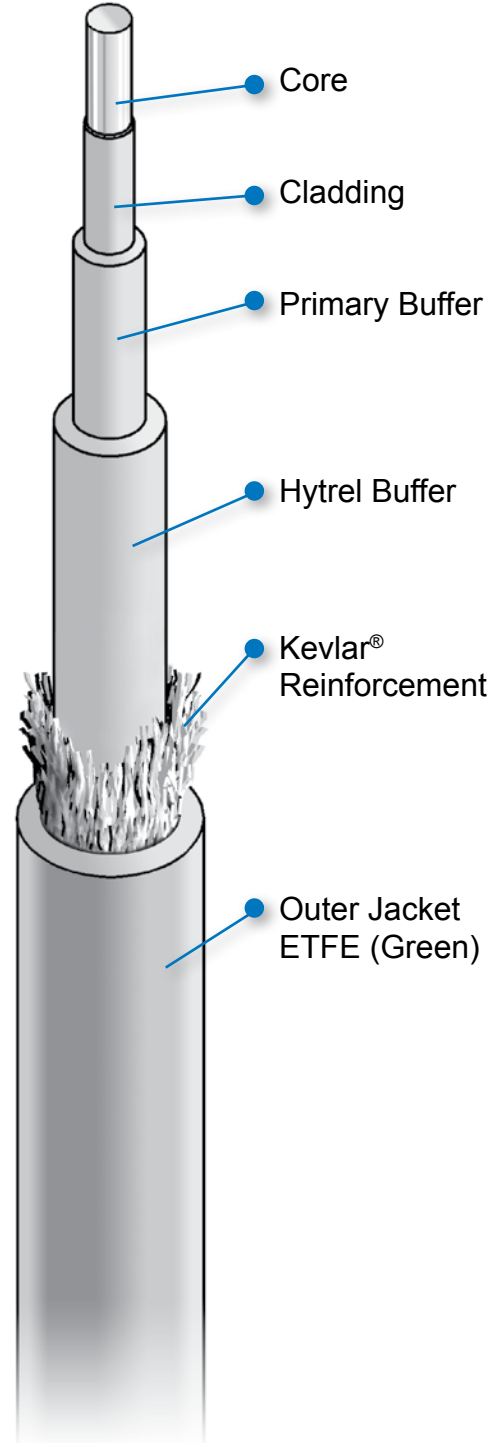
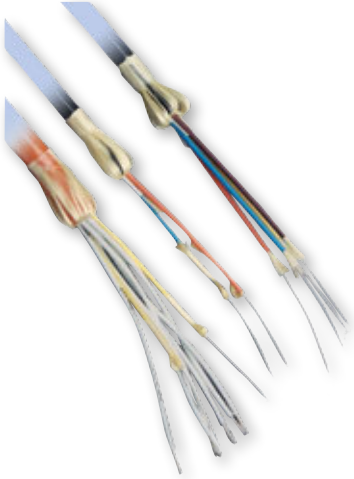

Cable Specifications	
Core/Mode Field Diameter	100 $\mu\text{m} \pm 4 \mu\text{m}$
Cladding Diameter	140 $\mu\text{m} \pm 3 \mu\text{m}$
Primary Buffer	500 $\mu\text{m} \pm 25 \mu\text{m}$
Secondary Buffer	900 $\mu\text{m} \pm 50 \mu\text{m}$
Jacket	.083 + .007 Inch Diameter
Attenuation: @ 850 nm @ 1300 nm	6.0 dB/km 4.0 dB/km
Bandwidth: @ 850 nm @ 1300 nm	100 Mhz/km Minimum 100 Mhz/km Minimum
Numerical Aperture	.290 + .015
Index Profile	Graded
Proof Test	>100 KPSI
Operating Temperature	-40° C to 85° C

Consult Factory for price in feet or meters and for Standard Length Tolerance

Kevlar® is a registered trademark of DuPont Company.



SERIES 963

No Dollars
or Quantity
Minimum orders

**NO
MINS.**

PROTOCOL-SPECIFIC HIGH-SPEED CABLE

For USB, Ethernet, SATA and other general-purpose/protocol-specific applications



All of the cables in this section have been selected for protocol compliance in accordance with industry-standard Ethernet, USB, and SATA/eSATA specifications and harsh mission-critical application environments. Without exception, cables have been designed and fabricated to optimize flexibility, weight reduction, ruggedness, and insulator quality. Each cable is offered with specific guidance as to shielding properties, impedance performance, attenuation, temperature rating, bend radius, weight, and maximum practical distance. Many of these cables are ideally suited for application with Glenair designed connectors such as our Series 80 Mighty Mouse, Series 79 Micro-Crimp, and other connectors designed for use in high-speed applications. All of the cable part numbers detailed here are in stock and ready for immediate, same-day shipment with no length or dollar minimums.

Glenair®

Glenair, Inc.
1211 Air Way
Glendale, CA
91201-2497
818-247-6000
sales@glenair.com
www.glenair.com

Compatible Contacts



Size 12 Differential Twinax Pin



Size 12 Differential Twinax Socket

Protocol Specific Cables
For USB, Ethernet, HDMI and Others
Selection Guide

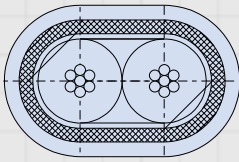

963-001
 100 Ohm differential parallel pair data cable

G-4

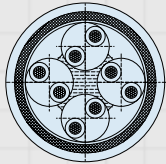

963-002
 1000 BASE-T Ethernet Cable with Polyurethane Jacket

G-5



963-003
 10G BASE-T Ethernet Cable with FEP Jacket

G-6

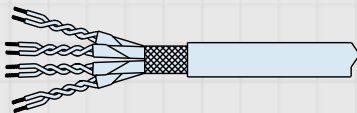

963-004
 10G BASE-T Ethernet Cable with PVC Jacket

G-7



963-005
 USB 2.0 Cable with FEP, Polyurethane or No Jacket

G-8

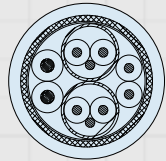

963-012
 USB 3.0 Cable with Polyurethane Jacket

G-9

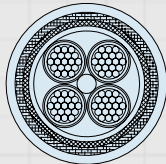

963-006
 110 Ohm Firewire Quad Cable with FEP, Polyurethane or No Jacket

G-10



963-013
 100 Ohm SATA/eSATA Cable with Polyurethane Jacket

G-11

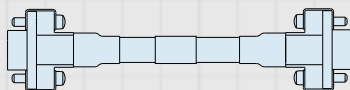

GWSM
 Glenair Spacewire Micro-D

G-12

Mighty Mouse High-Speed and Ultra-Twinax: high-speed performance and signal integrity in an ultraminiature package

Glenair has expanded the Mighty Mouse line to include contacts and connectors optimized for high-speed digital applications. A wide range of interconnect technologies are available, including

- *High-Speed* series 80 with DuPont™ Teflon® insulators for superior electrical performance in protocol-specific applications like eSATA and USB 2.0/3.0. These connectors are ideally suited for use with Ethernet, USB and other protocol-specific wire types presented in this chapter.
- Mighty Mouse *Ultra-Twinax* connectors utilizing size #12 Twinax contacts for differential pair applications such as LVDS and CML, and 963-001 100 Ohm differential parallel pair data cable

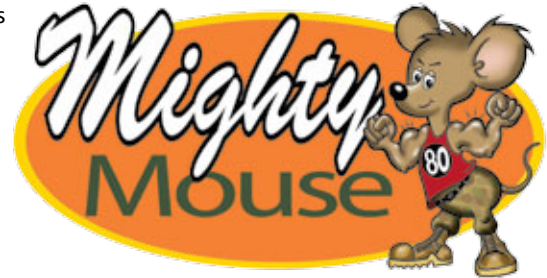

MIGHTY MOUSE HIGH-SPEED



Series 80 Mighty Mouse *High Speed* Connectors with DuPont™ Teflon® PFA Insulators

- For use with high-speed protocol wire including eSATA, 10GBASE-T, USB 2.0 / 3.0
- DuPont™ Teflon® PFA insulators for superior insertion loss and balanced impedance
- Series 801 double-start ACME thread and Series 804 push-pull quick disconnect connectors available
- Discrete components or overmolded cordsets

MIGHTY MOUSE ULTRA-TWINAX

- For ultra high-speed differential pair applications such as LVDS, CML and 963-001 100 Ohm differential parallel pair data cable
- Size #12 Twinax and hybrid contact arrangements
- Series 801 double-start ACME thread connectors
- Discrete components or overmolded cordsets

Series 80 Mighty Mouse *Ultra-Twinax* Connectors with Size #12 Twinax contacts



Mighty Mouse *ultra-twinax* plug and receptacle cutaway

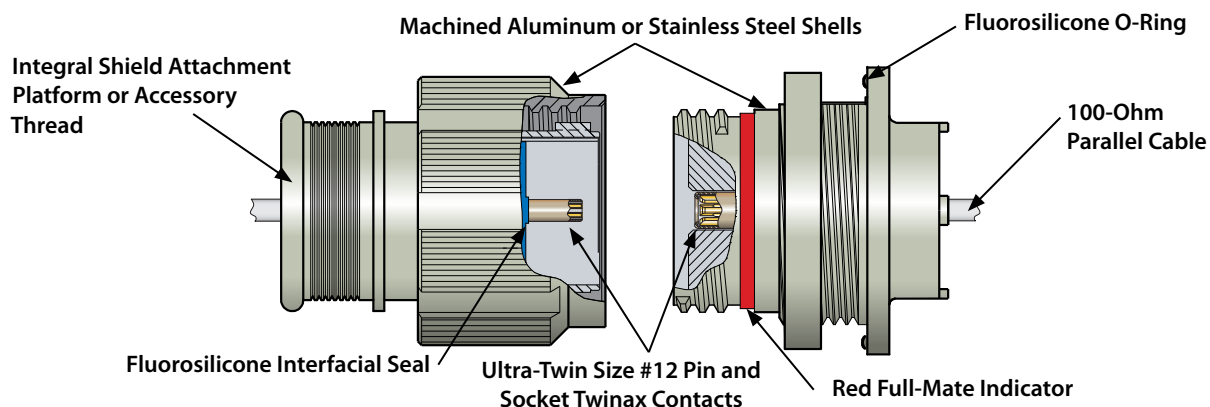

Protocol Specific Cables For USB, Ethernet, HDMI and Others Compatible Connectors



This table compares contact and wire spacing and bandwidth performance in miniaturized interconnect applications. As contact density increases, the performance of the interconnect improves. Note the position of the High-Speed PFA and Size #8 Mighty Mouse compared to standard Mighty Mouse, and the position of the Ultra-Twinax Mighty Mouse with performance up to 10 GHz. The Series 80 Mighty Mouse High Density (HD) connector also performs exceptionally well in bandwidths up to 5 GHz, by virtue of its high-density TwistPin contact insert arrangements.

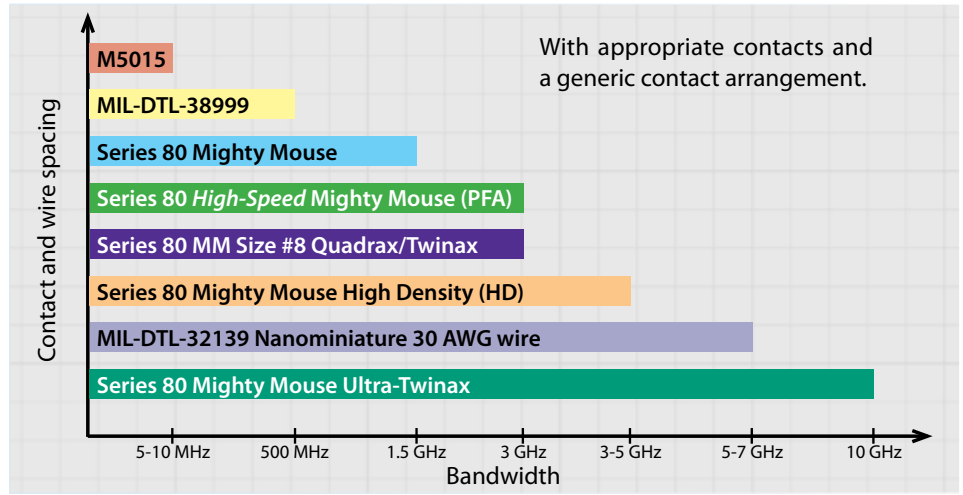

Mighty Mouse High Speed Contact Arrangements Mating Face View of Pin Connector (Socket Connector Numbers are Reversed)				
6 - 4	6 - 7	7 - 10	9 - 19	10 - 26
Shell Size 6 4 Size #23 Contacts	Shell Size 6 7 Size #23 Contacts	Shell Size 7 10 Size #23 Contacts	Shell Size 9 19 Size #23 Contacts	Shell Size 10 26 Size #23 Contacts

Mighty Mouse Ultra Twinax Size #12 Differential Twinax Contact Arrangements (Mating Face/Pin Connector)						
7-1	10-2	16-5	17-7	21-12	10-201	10-200
Shell Size 7 1 Size #12 Twinax Contact	Shell Size 10 2 Size #12 Twinax Contacts	Shell Size 16 5 Size #12 Twinax Contacts	Shell Size 17 7 Size #12 Twinax Contacts	Shell Size 21 12 Size #12 Twinax Contacts	Shell Size 10 2 Size #12 Twinax 4 Size #23 Contacts	Shell Size 10 1 Size #12 Twinax 12 Size #23 Contacts

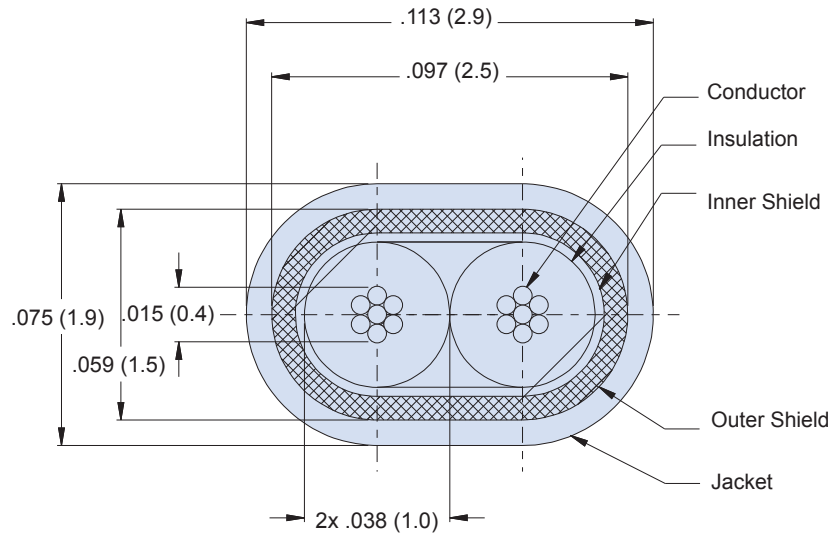

Glenair SuperSeal™ Ethernet and USB connectors are optimized for use with our Series 963 Ethernet and USB cables

963-001: 100 OHM DIFFERENTIAL PARALLEL PAIR DATA CABLE

Properties	
Impedance	100 Ohms \pm 10
Attenuation	0.25 dB/m @ 100 MHz
	.075 dB/m @ 500 MHz
	1.25 dB/m @ 1000 MHz
Impedance	100 \pm 10 Ohms
Capacitance	12.0 pF/ft (nom)
Velocity of Propagation	80%
Temperature Rating	150°C

Construction Details		
Data Pair	Conductor	2x 28 AWG (7/36) silver plated high strength copper alloy (.015" OD)
	Insulation	Extruded Foamed Fluoropolymer (.038")
	Colors	Blue and white
	Shield Coverage	Silver plated copper, 38 AWG, 95% minimum
Inner Shield		Aluminum/ Polyester tape, 100% coverage
Outer Shield		Round silver plated copper braid, 90% coverage
Jacket		Extruded FEP
Color		Transparent blue

Notes

Cable identified with manufacturer's name and part number.
 Cable is sold in 1 foot increments. Specify desired length on purchase order.

963-002
Tactical Cat 5e Ethernet Cable



963-002: 1000 BASE-T ETHERNET CABLE WITH POLYURETHANE JACKET

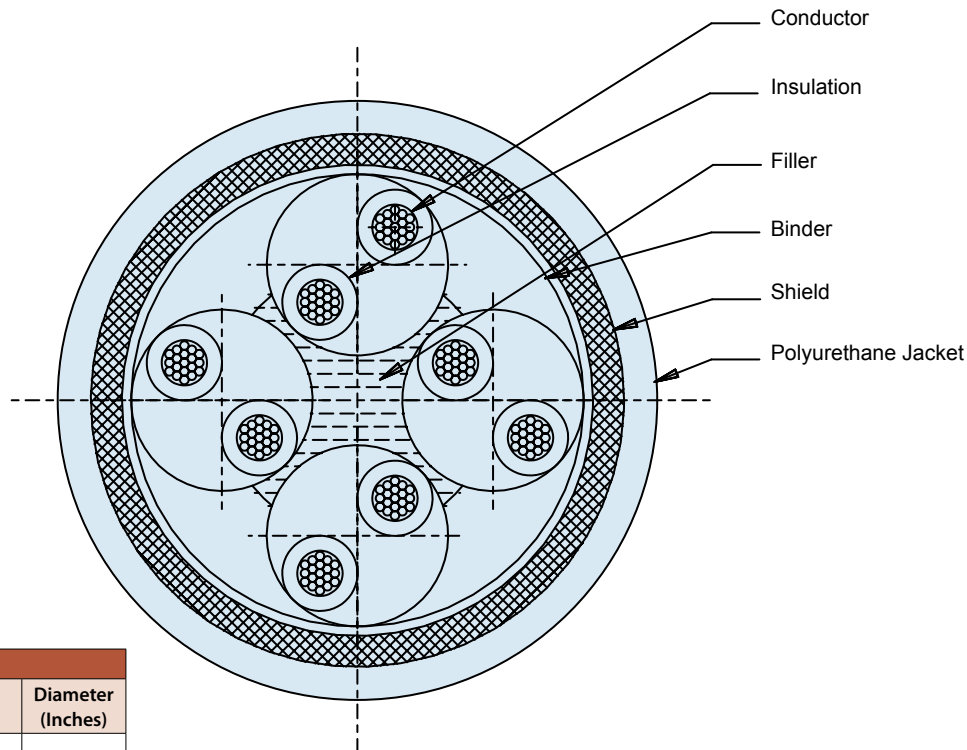

Construction Details		
	Details	Diameter (Inches)
Conductor	24 AWG 19x36 silver plated copper alloy	.0235
Insulation	Fluoropolymer	.045
Colors	Pair #1 white/blue and blue	.235
	Pair #2 white/orange and orange	.300
	Pair #3 white/green and green	
	Pair #4 white/brown and brown	
Two insulated conductors twisted together (varied lays)		

Properties	
Impedance	100 Ohms ± 15% (1 to 100 MHz)
Attenuation	8.0 dB/100 ft @ 100 MHz
NEXT	35.3 dB @ 100MHz
PSNEXT	32.3 dB @ 100 MHz
ELFEXT	23.8 dB @ 100 MHz
PSELFEXT	20.8 dB @ 100 MHz
Temperature Rating	200° C
Minimum Bend Radius	1.25" (dynamic) 1.00" (static)
Weight	4.8 lbs/100 ft
Max Cabling Distance	80 meters (100BASE-T)

Final Assembly	
Cable	Four twisted pairs cabled around a center filler
Binder	Skive PTFE tape
Shield 1	Aluminum polyester
Shield 2	38 AWG silver plated copper braid 80% coverage
Jacket	Polyurethane (Estane 58244) Color: Black .030" minimum jacket wall

Notes

Cable identified with manufacturer's name and part number.
 Cable is sold in 1 foot increments. Specify desired length on purchase order.





963-003 Avionic Cat 6a Ethernet Cable

963-003: 10G BASE-T ETHERNET CABLE WITH FEP JACKET

How to Order	
963-003-24	24 AWG
963-003-26	26 AWG

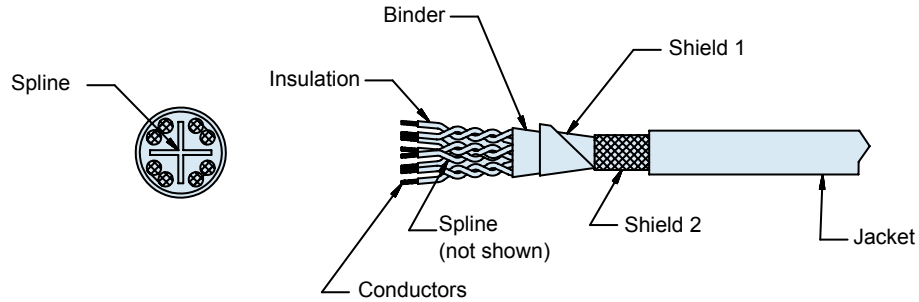

Construction Details		
	963-003-24	963-003-26
Conductor	24 AWG silver plated copper	26 AWG stranded silver plated copper
Insulation	FEP	PFA
Colors	Pair #1 white/blue and blue stripe Pair #2 white/orange and orange stripe Pair #3 white/green and green stripe Pair #4 white/brown and brown stripe	Pair #1 white/blue and blue stripe Pair #2 white/orange and orange stripe Pair #3 white/green and green stripe Pair #4 white/brown and brown stripe

Final Assembly		
	963-003-24	963-003-26
Conductors	Silver plated copper	Silver plated copper
Insulation	FEP	PFA
Cable	Four twisted pairs cabled around a center filler	Four twisted pairs cabled around a center filler
Spline	FEP	Fluoropolymer
Binder	Skive PTFE tape	Fluoropolymer tape
Shield 1	Aluminum mylar	n/a
Shield 2	38 AWG silver plated copper braid 90% coverage	silver plated copper braid 80% coverage
Jacket	FEP Color: Translucent blue .275" Nominal OD	PTFE laser printable jacket Color: White .220" nominal OD

Properties		
	963-003-24	963-003-26
Impedance	100 Ohms ± 10%	100 Ohms ± 10%
Attenuation (dB/100 Ft)	10 MHz - 2.4 100 MHz - 7.5 500 MHz - 17.7	10 MHz - 3.7 100 MHz - 11.2 500 MHz - 24.0
NEXT	10 MHz - 59.3 100 MHz - 44.3 250 MHz - 38.3 500 MHz - 33.8	10 MHz - 59.3 100 MHz - 44.3 250 MHz - 38.3 500 MHz - 33.8
SRL	10 MHz - 25.0 100 MHz - 20.1 250/500 MHz - 15.2	10 MHz - 25.0 100 MHz - 20.1 250/500 MHz - 15.2
Capacitance (pF/ft)	14.5 (nominal)	14.5 (nominal)
Velocity of Propogation	70% (nominal)	70% (nominal)
DWV	1.5 KV RMS	1.5 KV RMS
Temperature Rating	-55° to +200° C	-55° to +200° C
Minimum Bend Radius	1.4 Inches	.660 Inches
Weight	5.5 lbs/100 ft	3.05 lbs/100 ft
Max Cabling Distance	240 Feet (10GBASE-T)	188 Feet

Notes

Cable identified with manufacturer's name and part number.
 Cable is sold in 1 foot increments. Specify desired length on purchase order.
 Meets TIA-568B CAT-6A requirements when terminated to appropriate high speed connectors.
 Skydrol resistant, RoHS compliant and passes flamability requirements of FAR part 23 and 25, appendix F.

963-004: 10G BASE-T ETHERNET CABLE WITH PVC JACKET

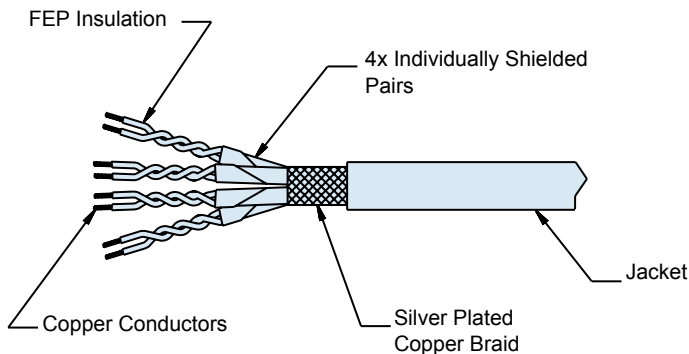

Construction Details	
Conductor	23 AWG solid copper alloy (.024" OD)
Insulation	Foam FEP (.057" OD)
Colors	Pair #1 white with blue stripe Pair #2 orange/white with orange stripe Pair #3 green/white and green stripe Pair #4 brown/white and brown stripe
Pair Shield	Aluminum mylar, 100% aluminum side facing out (.115" OD)
Overall Shield	Braid, silver plated copper 38 AWG, 85% minimum (.274" nominal OD)
Jacket	0.298" nominal OD

Properties	
Impedance	100 Ohms ± 10%
Attenuation (dB/100 M)	10 MHz - 5.7 100 MHz - 18.5 300 MHz - 33.3 600 MHz - 48.9 1000 MHz - 64
NEXT	10 MHz - 80 100 MHz - 72.4 300 MHz - 65.3 600 MHz - 60.8 1000 MHz - 67
SRL	10 MHz - 25 100 MHz - 20.1 300 MHz - 17.3 600 MHz - 17.3 1000 MHz - 18
Capacitance (pF/ft)	14.5 (nominal)
Velocity of Propagation	80% (nominal)
DWV	1000V RMS
Temperature Rating	-20° to +70° C
Weight	4.1 lbs/100 ft

Notes

Cable identified with manufacturer's name and part number.
Cable is sold in 1 foot increments. Specify desired length on purchase order.



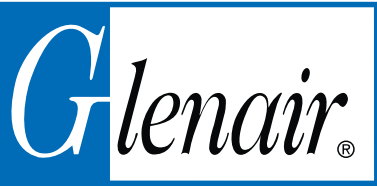

963-005
USB 2.0 Cable

963-005: USB 2.0 CABLE WITH FEP, POLYURETHANE OR NO JACKET

How To Order

Product Series

Basic No.

Cable Jacket Material

- 1 - Less Jacket
- 2 - FEP (translucent blue)
- 3 - Polyurethane, zero halogen, Estane 58244 TPU or equivalent (black)

963

- 005

- 2

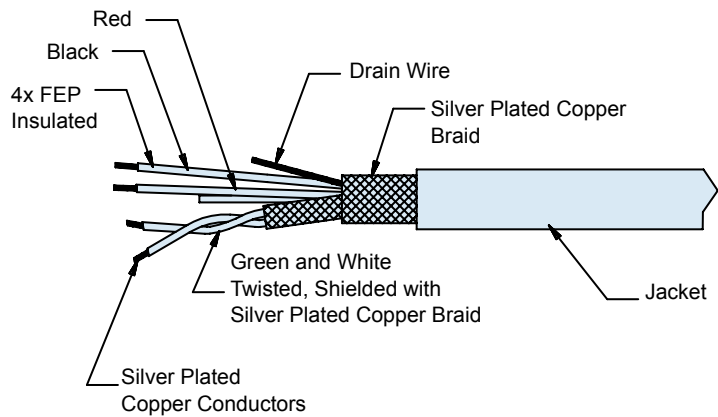
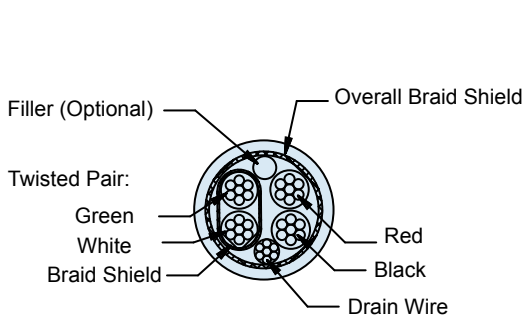

Properties	
Impedance	90 Ohms ± 10
Attenuation (dB/100 ft)	1 MHz - 1.2
	4 MHz - 2.4
	8 MHz - 3.5
	12 MHz - 4.1
	24 MHz - 5.8
	48 MHz - 8.2
	96 MHz - 11.6
	200 MHz - 19.5 400 MHz - 35.0
Skew	100 ps max / 16.4 feet (5 meters)
Velocity of Propagation	70% (nominal)
DWV	1000V RMS
Temperature Rating	FEP: -55° to +200° C Polyurethane: -30° to +105° C
Weight	2.9 lbs/100 ft

Construction Details		
Data Pair	Conductor	2x 26 AWG (19/38) silver plated copper alloy (.019" OD)
	Insulation	FEP (.035")
	Colors	Green and white
	Shield Coverage	Silver plated copper, 38 AWG, 95% minimum
Power Pair	Conductor	2x 22 AWG (19/34) silver plated copper alloy (.030" OD)
	Insulation	FEP (.050")
	Colors	Red and black
Drain Wire	Conductor	26 AWG (19/38) silver plated copper alloy (.019" OD)
	Filler	PTFE rod, optional
	Overall Shield Coverage	Silver plated copper, 38 AWG, 95% minimum (.176" nominal OD)
	Jacket Diameter	.200" nominal

Notes

Cable identified with manufacturer's name and part number.
Cable is sold in 1 foot increments. Specify desired length on purchase order.

963-012
High Data Rate Cable • USB 3.0 Type



963-012: HIGH DATA RATE CABLE • 3.0 USB TYPE WITH POLYURETHANE JACKET

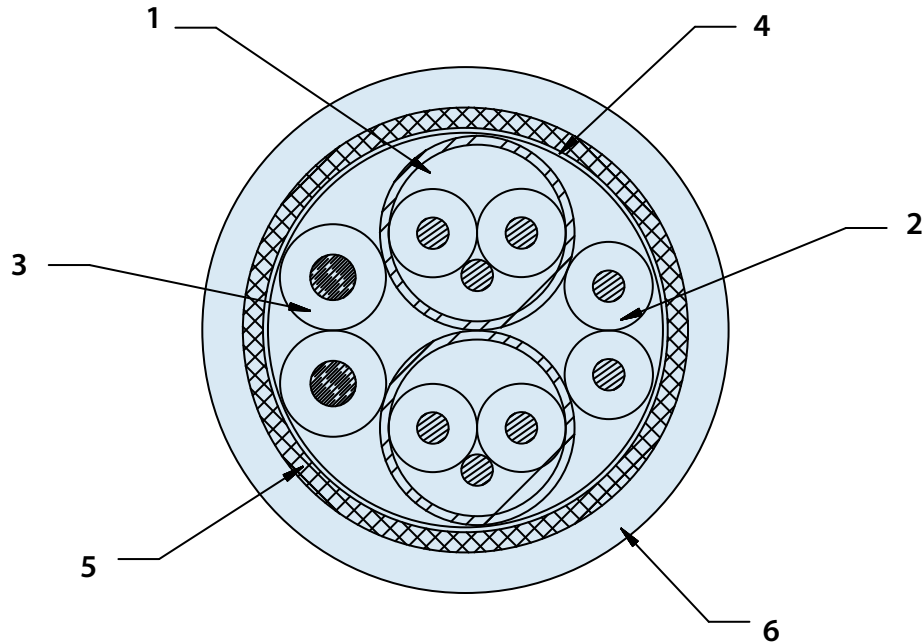

Construction Details			
1	2x Data Pair 90 Ohms (Twisted, Shielded)	Conductors	2x 26 AWG (19/38) silver plated copper
		Insulation	FEP
		Colors	Pair 1: Violet and orange Pair 2: Blue and yellow
		Drain	26 AWG (19/38) silver plated copper
		Shield	Al/Polyester, 50% lap (foil side in)
2	Data Pair 90 Ohms (Twisted)	Conductors	2x 26 AWG (19/38) silver plated copper
		Insulation	FEP
		Colors	Green and white
3	Power Pair	Conductors	2x 24 AWG (19/36) silver plated copper
		Insulation	FEP
		Colors	Black and red
4	Mylar Tape	50% Min Overlap	
5	Overall Shield	36 AWG silver plated copper braid. 90% coverage minimum	
6	Overall Jacket	Polyurethane, Ø .272 In nominal, black	

Properties			
Impedance	90 Ohms ± 10		
STP Performance (nominal)	f (GHz)	IL (dB/m)	Next (dB)
	1.25	-1.8	-74.6
	2.5	-2.6	-67.7
	5	-4.0	-53.1
	7.5	-5.7	-53.5
DWV	300VAC		
Temperature Rating	-30C to +105C		
Weight	47.8 lb/1000 ft		

Notes

Cable identified with manufacturer's name and part number.
 Cable is sold in 1 foot increments. Specify desired length on purchase order.

963-006: 110 OHM QUAD CABLE WITH FEP, POLYURETHANE OR NO JACKET
How To Order
Product Series
963
Basic No.
006
Cable Jacket Material

- 1 - Less Jacket
- 2 - FEP (translucent blue)
- 3 - Polyurethane, zero halogen, Estane 58244 TPU or equivalent (black)

2

Construction Details	
Conductors	24 AWG (19/36) silver plated copper alloy (.0235" OD)
Insulation	Foam FEP, .054" OD
Filler	FEP .022" nominal OD
Overall Binder	PTFE tape wrap
Overall Shield #1	40 AWG silver plated copper braid
Overall Shield #2	38 AWG silver plated copper braid
Jacket Diameter	.190" nominal, .200" max

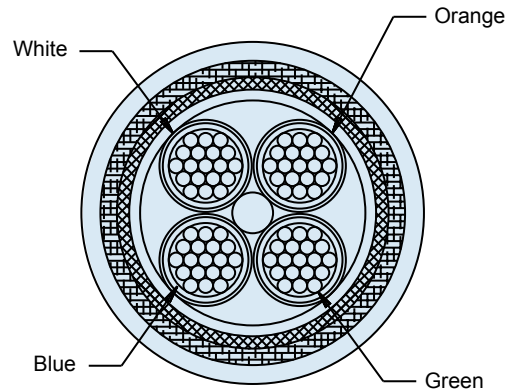

Properties	
Impedance	110 Ohms \pm 6 (measured differentially)
Attenuation (dB/100 ft)	10 MHz - 2.9 100 MHz - 7.5 500 MHz - 15.0 1 GHz - 22.5
Skew	2.0 PS/ft typical, 3.5 PS/ft Max (within pair)
Velocity of Propagation	80% (nominal)
Capacitance	12.5 PF/ft nominal (between pairs, ground floating)
DWV	1500V RMS conductor/conductor 1000V RMS conductor/shield
Temperature Rating	FEP: -55° to +200° C Polyurethane: -30° to +105° C
Weight	3.5 lbs/100 ft

Notes

Cable identified with manufacturer's name and part number.
 Cable is sold in 1 foot increments. Specify desired length on purchase order.

963-013: 100 OHM SATA/eSATA CABLE WITH POLYURETHANE JACKET

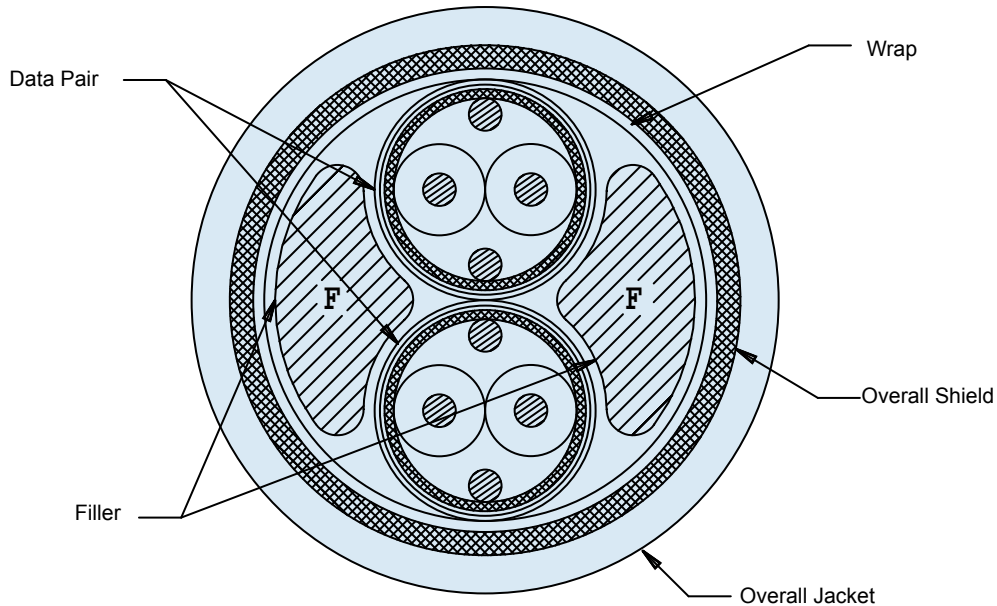

Construction Details	
Conductors	2x 28 AWG (7/36) silver plated copper
Insulation	.0115" NEWcel to .038" ± .002"
Drain Wire	2x 28 AWG (7/36) silver plated copper
Braid	44 AWG silver plated copper, 90% coverage minimum
Tape	.0015 Al/polyester, 50% lap (foil side in)
Jacket	.005" PFA to .099" ± .005
Wire Colors	white and blue (pair 1) white and orange (pair 2)
Filler	LSNW polyester
Wrap	.002" PTFE tape, 50% lap
Overall Shield	35 AWG tin copper braid, 90% coverage minimum
Overall Jacket	.035" polyurethane, .299" OD nominal, (black)
Marking	print on outer jacket in white ink
Temperature Range	-30°C to +130°C

Notes

Cable identified with manufacturer's name and part number.
Cable is sold in 1 foot increments. Specify desired length on purchase order.

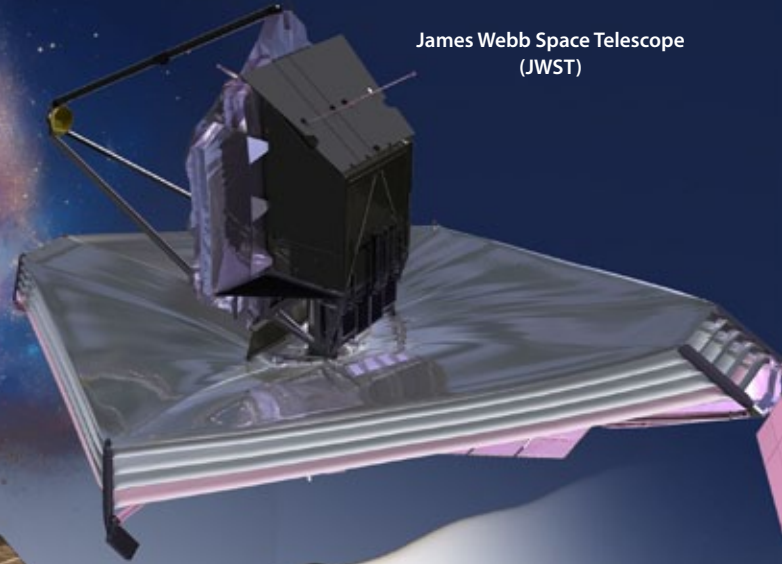

Spacewire

Reduced Cost of Ownership, Easy Integration, and High-Performance for Flight and Lab Grade Cable Assemblies.

The success of any space mission begins with reliable data transmission and Glenair Spacewire cables, built to meet the strict standards set forth by ECSS-E-ST-50-12C, make this a reality. Our Spacewire cables offer bidirectional, high speed data transmission rates up to 400 Mbits/s while significantly reducing cross talk, skew, and signal attenuation. By incorporating a serial, point-to-point cable, with low voltage differential signaling (LVDS) reduced costs are realized through an easily integrated data transmission cable. These features allow Spacewire cables to be incorporated across various satellite programs without the expense of costly design customization.

Spacewire: The Space Industry Data Transmission Standard

Glenair Spacewire assemblies begin with a high performance cable built with expanded polytetrafluoroethylene (ePTFE) insulation. This material allows for low-loss transmission of LVDS signals maximizing data-rates while allowing for the implementation of standard hardware protocols, thus eliminating the need for design customization and long lead time cable projects.

Typical Uses Include

- EGSE applications
- Radar sensor systems
- Hi-resolution camera equipment
- Sensor, mass-memory unit, and telemetry subsystem interconnections

Approved for Use by:

- ESA
- NASA
- JAXA
- RKA



Connector/Cable

- Laboratory and Space Grade Versions Available
- Qualified MIL-DTL-83513 Micro-D Connector
- Gold Plated Copper Alloy TwistPin Contacts
- Basic Cable, 4 Twisted Pair Cables and a Ground
- Epoxy Resin Potting
- EMI Banding Backshell

Performance

- 3 Amps
- Temperature Tolerance -200 to 180° C
- 100 Ω Impedance Shielded Signal Pair
- Very Low Skew, Signal Attenuation and Cross Talk
- 65dB Minimum Attenuation Shielding Effectiveness
- Low Magnetic Permeability IAW EIA-364-54

For more information contact Glenair at **818-247-6000** or visit our website at **www.glenair.com**



SERIES 20

SuperTwin™

Lightweight Composite Modular Connectors

Drop-in replacements for legacy modular rectangular connectors save weight, space, and assembly time

Today's high-performance commercial aircraft are looking for revolutionary materials and product designs that can reduce weight and improve reliability and performance. The Glenair Series 20 Super-Twin™ lightweight modular connector is a drop-in replacement for legacy cable and panel connectors that no longer meet these performance specifications—especially for ease of assembly, electromagnetic compatibility and size, weight and power optimization.

The Glenair Series 20 Super-Twin™ can accommodate a broad range of contact sizes and types from #23 to #8 signal, Quadrax, El Ochito®, power, and fiber. Modular inserts offer fast and flexible assembly and repair. Peripheral and grommet seals provide outstanding environmental protection. Keyed inserts and shells provide versatile polarization and protection against mis-mating. The innovative clamshell and banding porch design brings modern, state-of-the-art connector capabilities to modular cable and panel applications.



- For reduced size and weight cable and panel applications
- Lightweight composite shell with integral strain relief/banding porch
- Modular inserts support a wide range of contact sizes and types up to #8
- Polarization – both shell and inserts
- Center jackscrew with self-locking hardware



For more information contact Glenair at 818-247-6000 or visit our website at www.glenair.com U.S. CAGE code 06324

SERIES 20 Super-Twin™ Lightweight Composite Modular Connectors



SUPER-TWIN™ SHELLS AND INSERTS ARE ORDERED SEPARATELY

How To Order - Shells						
Sample Part Number	200-013	P	2	-XM	31	K
Series 20 Modular Connector	200-013 Plug Shell 200-014 Receptacle Shell					
Plug/Receptacle	P = Plug Shell, R = Receptacle Shell					
Size	Size 2					
Finish	XM = Electroless Nickel XB = No plating, black					
Polarization Code	2 digits: First digit 1 – 4 (factory installed) Second digit 1 – 4 (factory installed) Blank = keys supplied as kit					
MicroBand Option	K = MicroBand supplied. Blank = no MicroBand					

How To Order - Inserts						
Sample Part Number	200-005	P	2	-60	A	
Series 20 Modular Connector	200-005 Pin Insert 200-006 Socket Insert					
Pin/Socket Insert	P = Pin Insert, S = Socket Insert					
Size	Size 2					
Insert Pattern	60 = 60X #23 contacts					
Polarization	A, B, C, D, E, F, G, H (must match with shell polarization)					

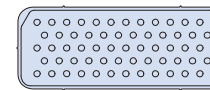

PATTERN 60
60 X Size 23 Contacts
DWV= 750 VAC

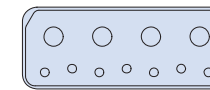

PATTERN 7W4
4 X Size 12 Contacts
7 X Size 20 Contacts
DWV= 1500 VAC

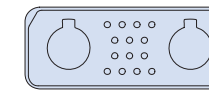

PATTERN 14Q2
2 X Size 8 Contacts
14 X Size 23 Contacts
DWV= 750 VAC

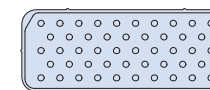

PATTERN 48
48 X Size 23 Contacts
DWV= 1300 VAC
DWV@50 000 ft = 800 VAC

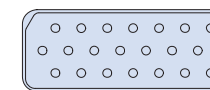

PATTERN 21
21 X Size 20 Contacts
DWV= 1500 VAC

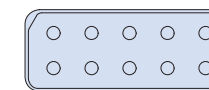

PATTERN 10
10x Size 16 Contacts
DWV= 1500 VAC



Modular inserts easily removed with available tool

Keyed, snap-in-place insert modules are currently available in six tooled layouts, accommodating size #23, #20, #16, #12 and keyed size #8 contacts (for use with Quadrax or El Ochito™ contacts).



Weight Study, Typical Regional Jet Airframe

Series 20 SuperTwin™
Mated Pair: 67g
Weight/Plane: 7,661g

Legacy rectangular: aluminum
Mated Pair: 192g
Weight/Plane: 22,103g

Legacy rectangular: composite
Mated Pair: 141g
Weight/Plane: 16,123g

Summary:
Using Series 20 composite instead of legacy aluminum connector saves **14,442 grams** (31.8 lbs) per plane.

Using Series 20 composite instead of legacy composite connector saves **8,482 grams** (18.6 lbs) per plane

Series 20 Super-Twin™ Performance

DWV	1500 Vac; 750 VAC (#23 contacts)
Shell-to-Shell	2.5 mΩ
Temp Range	-65°C / +125 °C
Shock*	50 g, half sine, 18x
Vibration*	Random, 8 hrs/axis, Type VI, cond. G (27.8 g)
Altitude Immersion*	12.1 kPa (15000 m / 49000 ft)
Lightning Indirect Effects	3 kA min

*Test by similarity, Series 79 Micro-Crimp

Spacewire

TECHNICAL SPECIFICATIONS

Notes:

1. Flight grade (cable Type F) assemblies to be screened IAW NASA EEE-INST-002, Table 2. Level 1 with 100% thermal vacuum outgassing (24 hours/+125°C/10⁻⁶ torr) reference Glenair Mod Code 429C.
2. Operating temperature - 200°C to +180°C. Reference Glenair Mod Code 428
3. Electrical performance:
Dielectric withstanding voltage: 600 VAC
Insulation resistance: 5000 megohms @500 VDC
4. Assembly to be identified with Glenair's name, Part Number, Cage Code and Date Code or ESCC Component Part Marking Standards.

Materials/finish:

- Shells/backshells - aluminum alloy/electroless nickel
- Insulators - high grade rigid dielectric/N.A.
- Contacts - copper alloy, gold plated
- Hardware - stainless steel/passivated

Back To Back Wiring
Diagram (GP)

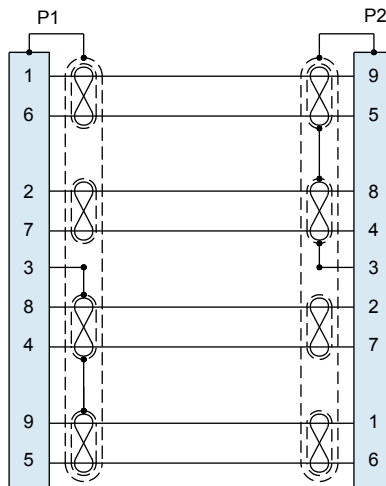

Single Ended Wiring
Diagram (P)

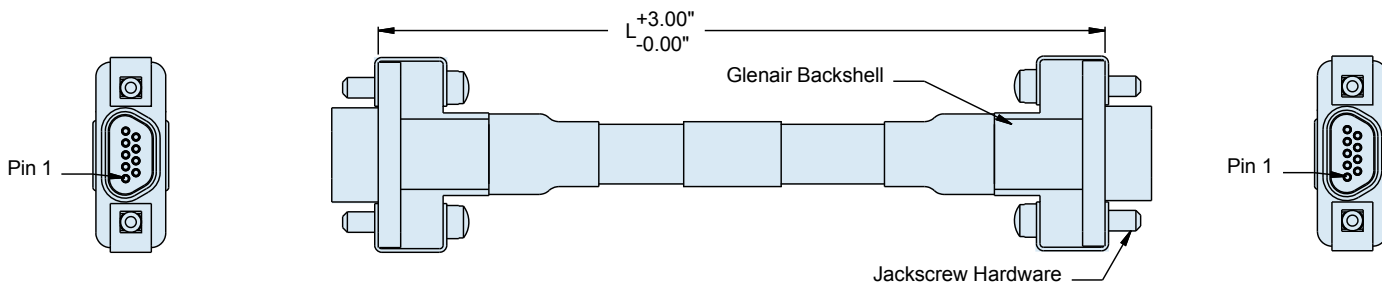
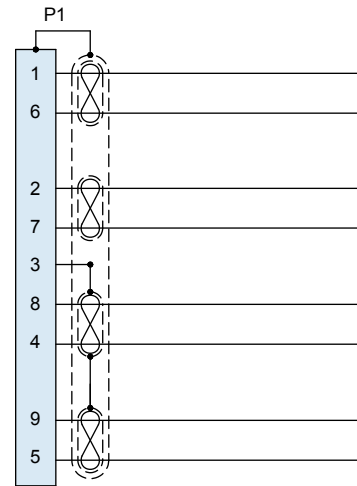

How To Order Spacewire										
Sample Part Number	GSWM	2	L	-9	GP	-6	F	B	-16	S
Product Series	GSWM—Glenair Spacewire Micro-D									
Shell Plating	2—Electroless Nickel 5—Gold									
Insulator Material	L—LCP									
Shell Size	-9									
Connector Type	P—Single Ended Pin (Plug) GP—Pin (Plug) Connector Both Ends									
Wire Gauge	-6—26 AWG -8—28 AWG -0—30 AWG (30 AWG—Lab Only)									
Cable Type	F—Flight Grade L—Lab Grade									
Termination Option	B—Backshell									
Cable Length In Inches	-16 = 16 inches (12 inches minimum)									
Hardware	S—Male Slotted Jackscrew P—Female Jackpost									



MICRO CRIMP

Series 79 Micro-Crimp: The high-performance rectangular with advanced EMC and electrical performance

- Mighty Mouse rectangular series connector
- Crimp, PCB, fiber optic, coax, power and pitot
- Precision machined aluminum shells sealed to IP67
- High-density #23 contact contact arrangements set on .076" centers
- Blind mating for rack and panel applications
- Over 30 tooled contact arrangements
- Integrated ground spring for improved EMI shielding



Cable Plug

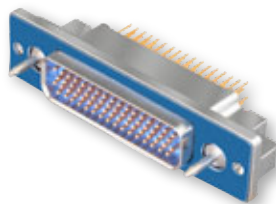

Crimp Receptacle

Blind Mate Guide Pins and Sockets	
<p>Guide Pins Connector may be supplied with stainless steel non-removable guide pins.</p>	<p>Guide Sockets Connector may be supplied with stainless steel non-removable bushings.</p>

Selected Contact Types



SERIES 79 Micro-Crimp

High-Performance Specifications	
Current rating	Contact size #23 5 Amps, size #16 13 Amps, size #12 23 Amps maximum
Voltage rating (DWV)	Contact size #23 500 VAC rms. size #16 and #12 1800 VAC rms. Sea level.
Insulation resistance	5000 megohms minimum
Operating temperature	-65° C. to +150° C.
Contact resistance	5 milliohms maximum
Water ingress protection	IP67
Shielding effectiveness	>75 dB attenuation from 100 MHz to 1000MHz, >60dB 1GHz to 4GHz, >40dB 4GHz to 10GHz.

Materials and Finishes	
Insulators	Liquid crystal polymer, 30% glass-reinforced
Shell	Aluminum alloy
Interfacial seal and grommet	Fluorosilicone
Contact and insert retention clips	Copper alloy, heat-treated, unplated
Jackposts and guide pins	Stainless steel, passivated
EMI Shroud for right angle PCB	Aluminum alloy
Trays for right angle PCB	Thermoplastic
Spring, EMI (plug)	Stainless steel or copper alloy, gold plated

Shell Size	Contact Arrangement	Contact Quantity		
		#23	#16	#12
A	A-5	5	—	—
B	B-2P2	—	2	—
	B-9	9	—	—
C	C-13	13	—	—
D	D-15	15	—	—
	D-3P3	—	3	—
	D-7P2	5	2	—
E	E-11P2	9	2	—
	E-19	19	—	—
	E-7P3	4	3	—

Shell Size	Contact Arrangement	Contact Quantity		
		#23	#16	#12
F	F-15P2	13	2	—
	F-23	23	—	—
	F-5P5	—	5	—
G	G-33	33	—	—
H	H-10P4	6	—	4
	H-29P7	22	7	—
	H-36P2	34	—	2
	H-54P2	52	2	—
	H-5P5	—	—	5
	H-66	66	—	—

Shell Size	Contact Arrangement	Contact Quantity		
		#23	#16	#12
J	J-17P4	13	4	—
	J-25P2	23	2	—
	J-33	33	—	—
	J-7P7	—	7	—
K	K-27P4	23	4	—
	K-35P2	33	2	—
	K-43	43	—	—
	K-9P9	—	9	—
L	L-6P6	—	—	6
	L-78	78	—	—
M	M-102	102	—	—

Series 79 Micro-Crimp Product Selection Guide



Crimp Terminated Cable Connectors

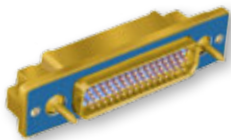

Crimp Terminated Panel Mount Connectors



Straight PCB Panel Mount and Free-Standing Connectors



Right Angle PCB Panel Mount and Free-Standing Connectors



Backshells and Accessories, EMI Adapters and Protective Covers

Inside a Series 79 Micro-Crimp Connector

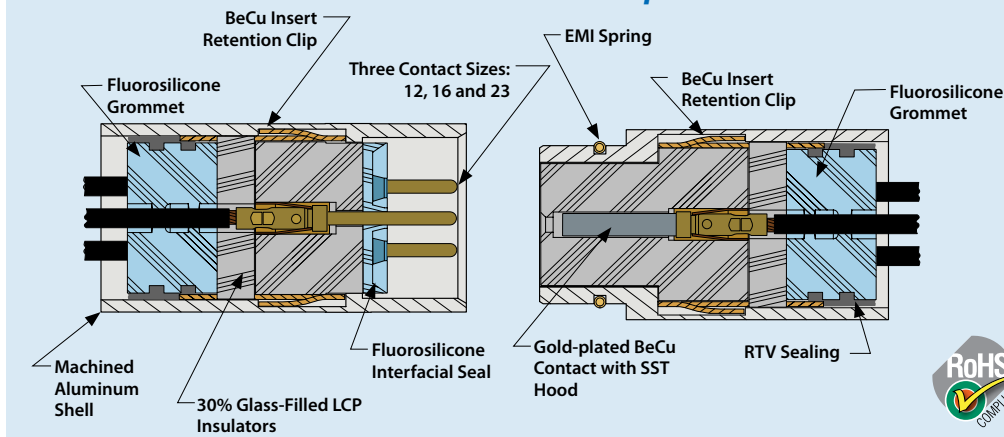

For more information contact Glenair at **818-247-6000** or visit our website at www.glenair.com











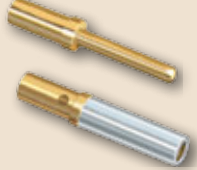

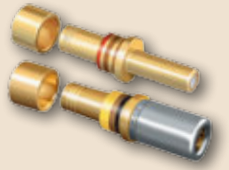
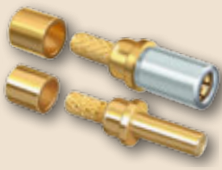

SERIES 85

**NO
MINS.**
No Dollar
or Quantity
Minimum Orders

HIGH-PERFORMANCE CONNECTOR CONTACTS

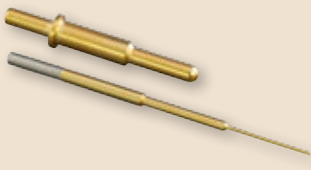
For every application requirement, from standard signal and power to opto-electronics

				
#23 Signal	#20HD Signal	#20 Signal	#16 and #12 Signal	#16 and #12 Coaxial
				
#12 50 Ohm Matched Impedance Coaxial	Pneumatic	High-Ampacity LouverBand	Thermocouple	
				
#12 Differential Twinax	#8 100 Ohm Quadrax	#8 100 Ohm Differential Twinax	#8 Power	
				
Concentric Twinax	Printed Circuit Board	Opto-Electronic	Size #16, #20, #23 Fiber Optic	

Glenair has developed an extensive range of innovative contacts including solutions for fiber optic and pneumatic applications. The development of our own range of high-performance contacts was a key step in gearing Mighty Mouse, Micro-Crimp, PowerTrip, and our many other innovative connector solutions to meet any interconnection challenge. This page highlights a selection of these high-performance contacts, from standard 39029 crimp signal and power contacts to our own unique shielded differential Twinax contact, miniaturized fiber optic contacts and highly specialized gas and pneumatic contact solutions. All our contacts are supported with appropriate extraction and crimp tools—and of course the wire and cable catalogued in this book. As always, these Glenair technologies are available with no dollar or quantity minimums, and are in-stock and ready for immediate, same-day shipment.



Glenair, Inc.
1211 Air Way
Glendale, CA
91201-2497
818-247-6000
sales@glenair.com
www.glenair.com

Glenair High-Performance Cable Part Number Index



Part Number	Page
961-001	E-6
961-002	E-7
961-003	E-8
961-004	E-9
962-001	D-4
962-002	D-6
962-003	D-7
962-004	D-8
962-005	D-9
963-001	G-4
963-002	G-5
963-003	G-6
963-004	G-7
963-005	G-8
963-006	G-10
963-012	G-9
963-013	G-11
963-019	C-4
963-020	C-5
963-021	C-6
963-022	C-7
963-023	C-8
963-024	C-9

Part Number	Page
964-002	F-6
964-003	F-8
964-004	F-10
964-005	F-11
964-006	F-12
964-007	F-7
964-008	F-9
964-009	F-13
GWSM	G-12
M22759/11	B-6
M22759/16	B-8
M22759/18	B-10
M22759/32	B-12
M22759/33	B-14
M22759/34	B-16
M22759/44	B-18
M22759/45	B-20
M22759/46	B-22
M22759/90	B-24

WHY CHOOSE **GLENAIR**

for your next interconnect cable and harness application?



Harsh Environment Overmolded Multi-Branch Assemblies

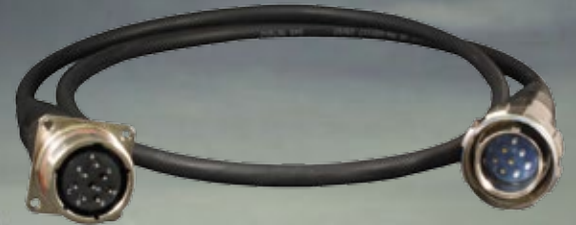

Harsh Environment Fiber Optic/Electrical Assemblies



Inside-the-Box Fiber Optic/Electric Pigtail Assemblies

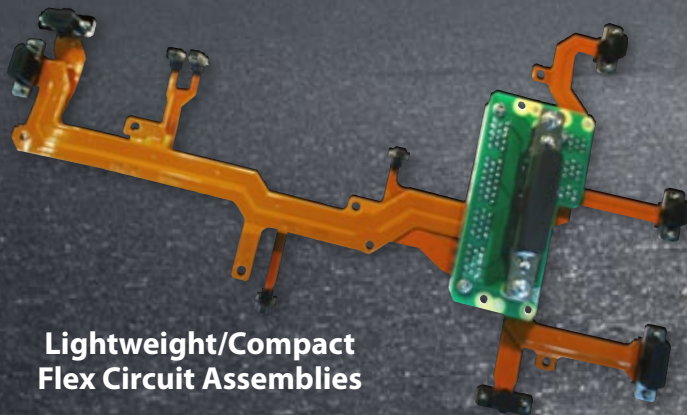

Lightweight/Compact Flex Circuit Assemblies



Multi-Branch Assemblies with Protective Fabric Braiding

Glenair has been the go-to cable house for high-performance interconnect cable assemblies for more than 50 years. We specialize in delivering terminated, tested cable harnesses and assemblies with 100% reliability and quality control. We offer complete, turnkey cable assembly services from design engineering to fabrication and test, and are qualified to all military and commercial aerospace standards.

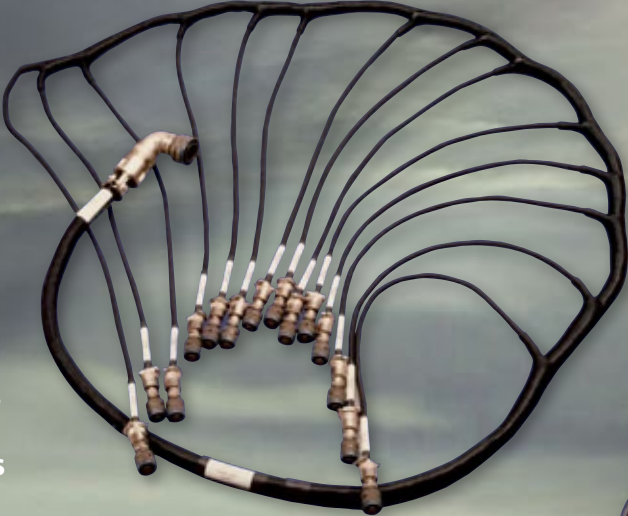

Repairable Assemblies
with Glenair Shield
Termination Backshells
and Cable Clamps



Harsh
Environment
Overmolded
Cables



Complex Interconnect Assemblies
with Industry-Standard
Connectors and Fittings



Wired, Terminated
and Tested Conduit
Assemblies



Glenair[®]

Glenair, Inc. · 1211 Air Way
Glendale, CA 91201-2497
818-247-6000 · www.glenair.com



Out of This World
**INTERCONNECT
SOLUTIONS**

Glenair, Inc.

1211 Air Way • Glendale, California • 91201-2497
Telephone: 818-247-6000 • Fax: 818-500-9912 • sales@glenair.com
www.glenair.com

**Glenair Power
Products Group**

860 N. Main Street Extension
Wallingford, CT
06492

Telephone:
203-741-1115
Facsimile:
203-741-0053
sales@glenair.com

Glenair UK Ltd

40 Lower Oakham Way
Oakham Business Park
P.O. Box 37, Mansfield
Notts, NG18 5BY England

Telephone:
+44-1623-638100
Facsimile:
+44-1623-638111
sales@glenair.co.uk

Glenair Microway Systems

7000 North Lawndale Avenue
Lincolnwood, IL
60712

Telephone:
847-679-8833
Facsimile:
847-679-8849

Glenair Nordic AB

Gustav III : S Boulevard 46
S - 169 27 Solna
Sweden

Telephone:
+46-8-50550000
Facsimile:
+46-8-50550001
sales@glenair.se

Glenair Electric GmbH

Schaberweg 28
D. 61348 Bad Homburg
Germany

Telephone:
06172 / 68 16 0
Facsimile:
06172 / 68 16 90
germany@glenair.com

Glenair Iberica

C/ La Vega, 16
45612 Velada
Spain

Telephone:
+34-925-89-29-88
Facsimile:
+34-925-89-29-87
sales@glenair.es

Glenair Italia S.p.A.

Via Del Lavoro, 7
40057 Quarto Inferiore –
Granarolo dell'Emilia
Bologna, Italy

Telephone:
+39-051-782811
Facsimile:
+39-051-782259
info@glenair.it

Glenair France SARL

7, Avenue Parmentier
Immeuble Central Parc #2
31200 Toulouse
France

Telephone:
+33-5-34-40-97-40
Facsimile:
+33-5-61-47-86-10
sales@glenair.fr

